



Lifting your dreams

ROUGH TERRAIN CRANE

GR-1300XL-4

130 TON (118.0 METRIC TON) CAPACITY

NEXT GENERATION



Photo: optional model

Next-Generation 130 Ton RT

The GR-1300XL-4 is redefining the rough terrain crane market. Its six-section boom can extend up to 183.7 feet using a reliable telescoping pinning system, making it the longest boom of any rough terrain crane in the 130 US ton weight class. With a compact carrier length of just 28 feet on a two-axle system and a self-removable counterweight, the GR-1300XL-4 can be transported to job sites easily and efficiently. Tadano's "Smart Chart" is also on-board, allowing the crane's work performance to be maximized.

The GR-1300XL-4's new design offers improved safety, greater work efficiency, environmental integrity and exceptional quality. This new, next-generation crane is ready to work for you.

Crane capacity: 130 ton (118.0 metric ton)
6-section boom: 40.0 ft – 183.7 ft (12.2 m – 56.0 m)
2-staged bi-fold jib: 33.8 ft / 59.1 ft (10.3 m / 18.0 m)

Maximum lifting height:
182.1 ft (55.5 m) [Boom]
237.9 ft (72.5 m) [Boom + Jib]

Maximum load radius:
175.0 ft (53.3 m) [Boom]
205.0 ft (62.5 m) [Boom + Jib]

Overall length: approx. 48' 2-3/4" (14,700 mm)
Overall width: approx. 10' 10-1/2" (3,315 mm)
Overall height: approx. 13' (3,950 mm)

ROUGH TERRAIN CRANE **GR-1300XL-4**

Photo: optional model.

Superstructure	
Ultimate Boom for Rough Terrain Crane	03
New Superstructure Frame	
Winch Drum Camera	04
Catwalk for Easy Access to Cab	
Tiltable Cab	
Two Winches with Cable Follower	
Optimally-Designed Cab	05
Load Moment Indicator [AML-E]	
Large Multi-Function Display	
Seat Adjustment	
Adjustment of Control Lever Stand	
Multi-Function Display Operation Switch	
Safety Control for Boom Raising Operation	
Visibility	
Jib	07
Single Telescopic Cylinder Boom	
Asymmetric Outrigger Extension Width Control	
Smart Chart System	

Carrier	
Travel Speed	09
Smooth Transmission	
High-Performance Engine	
New Carrier Frame	
TADANO View System	10
Clearance Sonar	
Improved Accessibility to Cab	
Axle	
Four Steering Modes	
Dashboard Indicator and Warning Symbols	11
Efficient Transportability	12
Mounting and Dismounting Systems	
Reduced Fuel Consumption	13
HELLO-NET	
HELLO-DATA LINK	
Standard Equipment	

The Longest Boom Among 130 Ton RTs

40.0 ft – **183.7 ft**
(12.2 m – 56.0 m)

Two-Trailer Transportation

COUNTERWEIGHT: **43,500 lbs**
(19,800 kg)

GVW: **114,600 lbs**
(51,950 kg)



Carrier length: approx. **28 feet**
(8,530 mm)

Compact Carrier with Two Axles





Ultimate Boom
for Rough Terrain Crane

Superstructure

The rounded boom is made of high-tensile steel, which allows for decreased boom weight as well as increased boom strength. In addition, the high-performance AML-E ensures operational safety.

Longest Boom and Speedy Operation

Max. boom length: **183.7 ft (56.0 m)**

Telescoping mechanism:

Single hydraulic cylinders with pinning system

Boom sections: 6

New Superstructure Frame

When developing the crane structure, importance is attached to the shape that is best suited for crane operation.

FEM analysis is used to create the design.

It is also important that the slewing structure be true to Tadano's original concept and be both rigid and compact while maintaining a desirable overall height.

*FEM: Finite Element Method



NEW DESIGN

Emergency Engine Stop Switch



Rubber Floor Mat



Outrigger Control Panel



Winch Drum Camera



Stowed position when transporting

Two-Roll Sunshade



Adjustable in any position

Longer Wiper Blade

Flat Windshield

Two Winches with Cable Follower

Both the main winch and the auxiliary winch have powerful line pull and operate at high speeds thus enhancing work efficiency.

*Maximum permissible line pull may be affected by wire rope strength.



Photo: optional mode



Catwalk for Easy Access to Cab

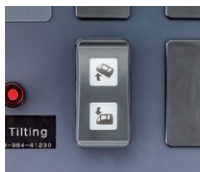

Cab tilt indicator and switch

Tiltable Cab

You can operate the crane comfortably by tilting the cab during high hoisting operations such as lifting with the jib. The cab tilting angle is between 0° and 20°.



Optimally-Designed Cab

Crane cab and equipment designed for safety and operational efficiency.



Load Moment Indicator [AML-E]

Large Multi-Function Display

The 10.4-inch color touch panel consolidates operation information and settings for increased work efficiency and comfort. The touch panel is pressure-sensitive to handle gloved operation.

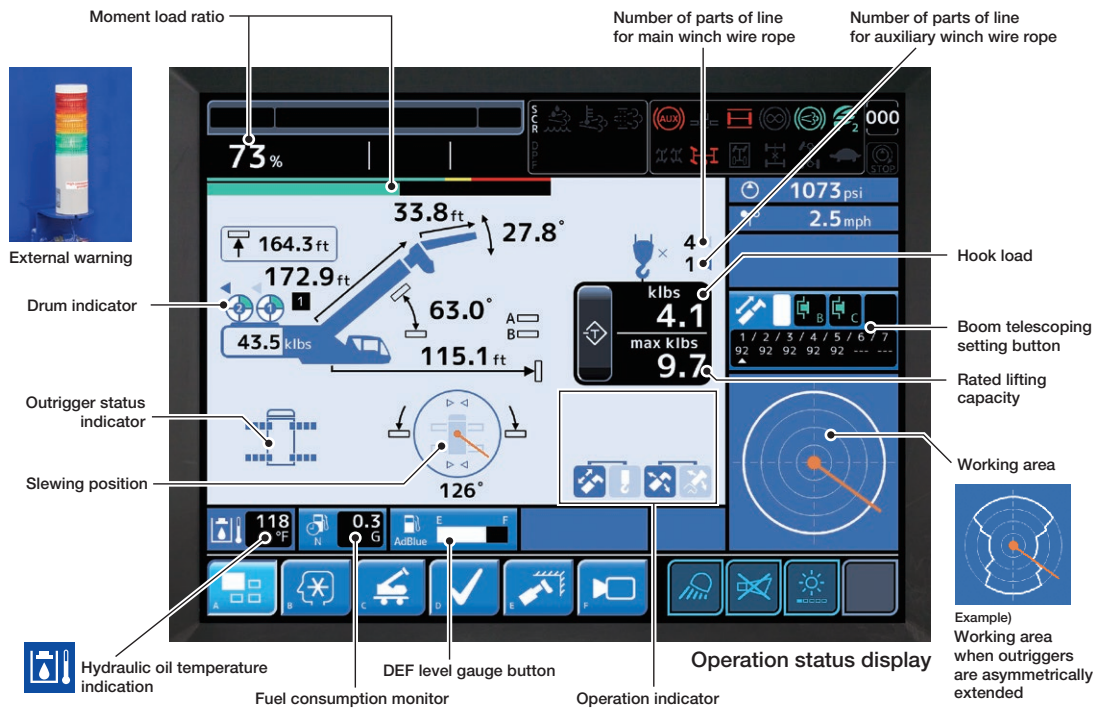

Winch drum monitoring camera
* The camera image in the photo are simulated.



Operation status



working area setting

Seat Adjustment

Multiple seat adjustment positions for ease of operation.



Adjustment of Control Lever Stand

- The control lever stand has a 3-stage adjustment feature.
- Before you enter or exit the cab, or when you complete the crane operation, set the control lever stand on the left to the stowing position.
- The unlock lever is used by pulling to adjust for all positions of the control lever stand.



The control levers are smooth and responsive to the operators touch.

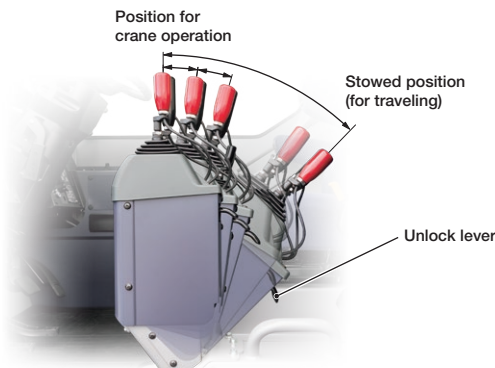

Multi-Function Display Operation Switch

Convenient hand controls are also available for when operating the touchscreen is difficult (for instance when the seat is sliding back).



Safety Control for Boom Raising Operation

Prevent overload using boom raising operation for lifting a load off the ground.

*Release switch available for emergency operation

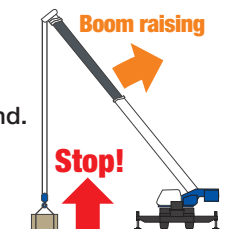

Visibility

The shape and height of the instrument panel as well as the angle of the windshield have all been designed for optimum forward visibility.

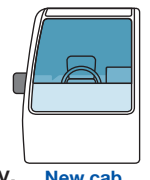

New cab

Jib

Extra reach is provided by a 2-staged bi-fold lattice type hydraulic offset jib that stows alongside the base boom section and features self-stowing jib mounting pins.

When erected, the jib can be offset 5° - 40° from the main boom center line, thus increasing operating range.

Hydraulic Offset Jib (5° - 40°)

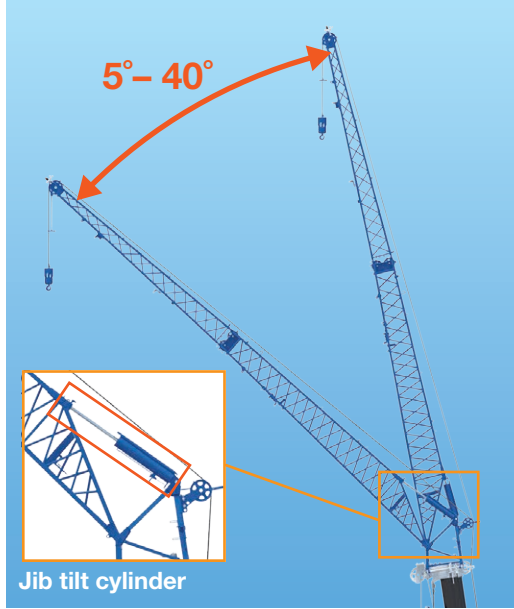

Assist Cylinder for Jib

When mounting and stowing the jib, the assist hydraulic cylinders are used resulting in increased work efficiency and safety.



Single Telescopic Cylinder Boom

For extension and retraction of sections, the 6-section, box type construction consists of 1 base section and 5 telescopic sections and are extended by a single telescoping cylinder.

All sections are fully extended/retracted automatically and locked in the selected working position.

Outline of Telescoping Mode

The boom telescope of this crane is performed with one telescoping cylinder. Each telescopic section is extended and fixed with pins in sequence from the top with several telescoping modes based on the designated job plan.

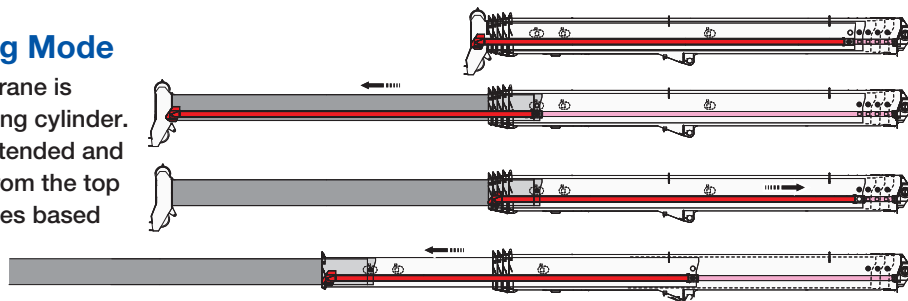

Telescoping Status Display

A single cylinder and each section of the boom's actual condition are displayed on the AML-E by activating the telescoping monitor switch.



Telescoping status indicator

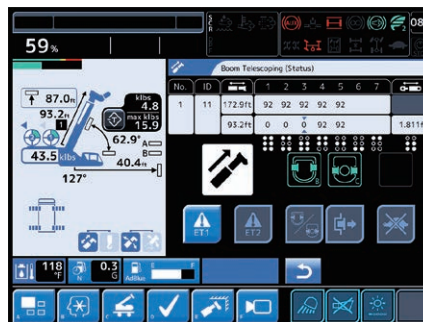

Telescoping status screen

Asymmetric Outrigger Extension Width Control

When operating the crane with the asymmetric outriggers extended, the AML-E detects the extension width of all of the crane's outriggers (front, rear, left and right) to measure maximum work capacity in each area. When slewing the boom from the longer outrigger area to the shorter outrigger area, the AML-E detects the motion and displays the maximum capacity according to the extension width of each of the outriggers, and brings the motion to a slow stop before it reaches the maximum capacity. The AML-E's slow stop function will help to minimize any safety risks even in the cases of operator error.



- A: Over-front B: Over-rear
- C: Over-side D: Over-side
- E: Rated Load [O/R max.]
- F: Rated Load [O/R mid.]
- G: Rated Load [O/R mid.]
- H: Rated Load [O/R min.]

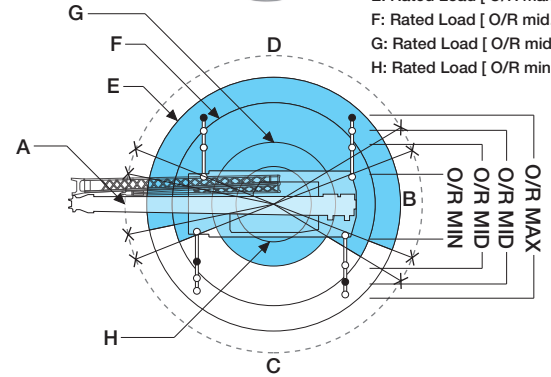
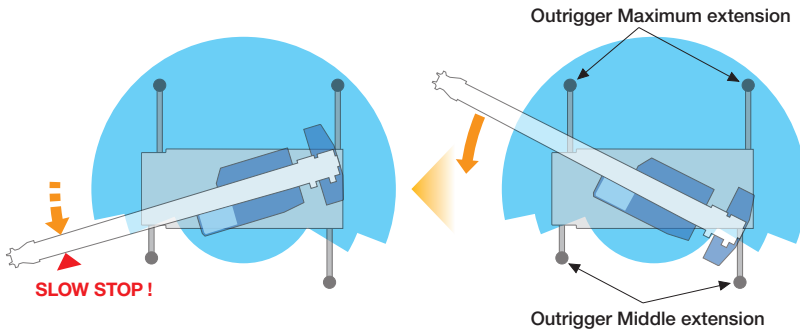

Smart Chart System

The newly-developed Smart Chart expands the working area, allowing you to get the best crane performance in any outrigger extension setup.

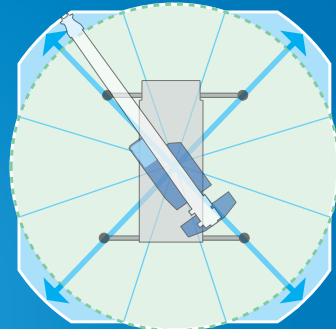
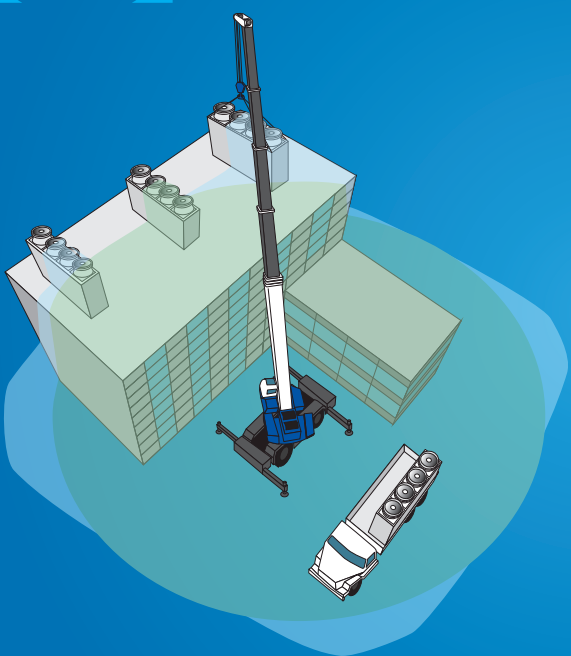

Under maximum outrigger extension setups
The Smart Chart taps the potential of a crane by expanding the conventional circular working area into a square one, improving work safety and efficiency.

Performance comparison graph (Smart Chart)

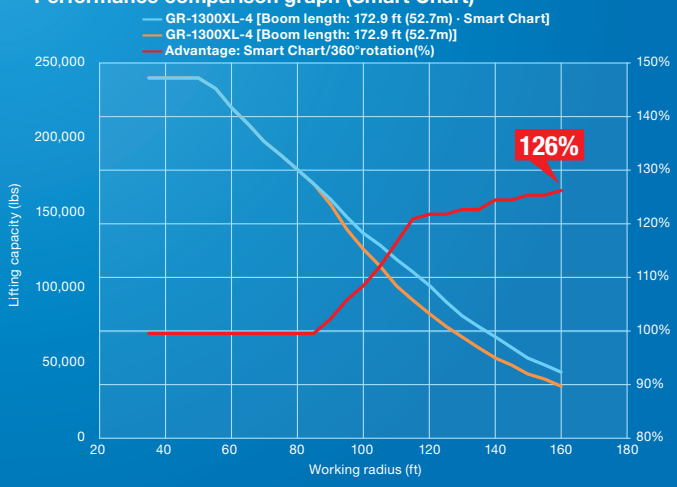

Carrier

The GR-1300XL-4 has a compact width/height 2-axle carrier which offers improved maneuverability and reduced footprint for ease of transportation.



Travel Speed: 12 mph (19 km/h)

Smooth Transmission

- Electronically controlled, fully automatic transmission.
- Torque converter with full powershift driving axle selector.
- 5 forward and 2 reverse speeds, constant mesh.

2 speeds - High range - 2 wheel drive; 4 wheel drive

3 speeds - Low range - 4 wheel drive

Photo: optional model

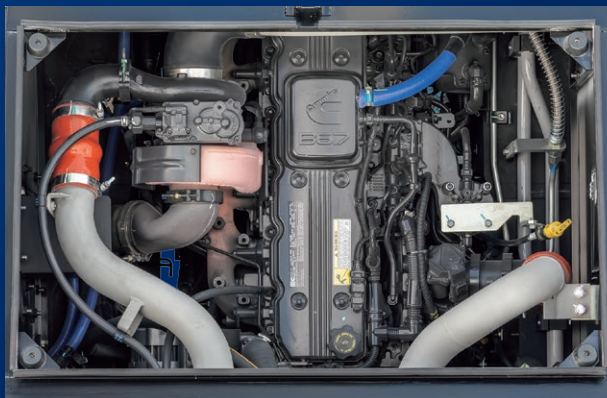

High-Performance Engine

Cummins B6.7

4 cycle, turbo charged and after cooled

Max. output: Gross 280 HP (209 kW) at 2,200 min⁻¹ {rpm}

Max. torque: 850 ft-lb (1,152 Nm) at 1,500 min⁻¹ {rpm}

New Carrier Frame

The new carrier frame design is developed and built so that its light weight is compatible with its high rigidity to achieve an advanced level of performance and highly-stabilized maneuverability for the new model of crane.

*Compared with our conventional crane models

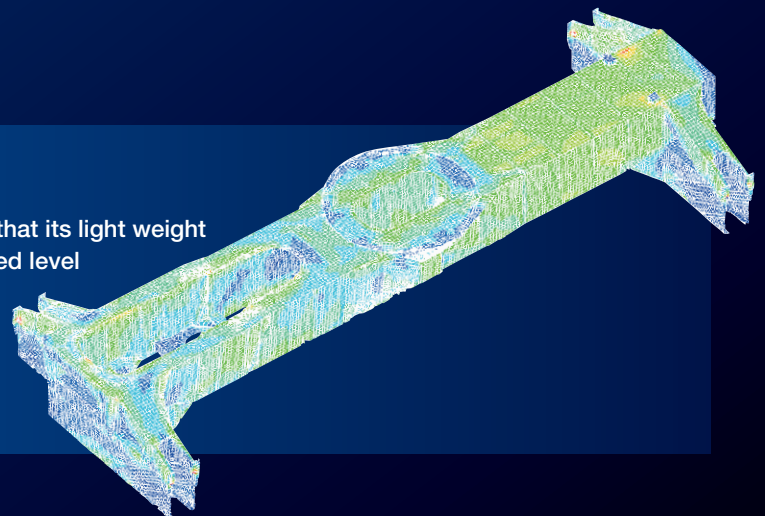

TADANO View System

Supports safety confirmation through an above-the-vehicle image shown on the large multi-function display.

*Camera range is limited. Do not rely only on the image. Confirm safety around the vehicle directly before driving.

Right front view monitor*



Right front view camera



Right front and Rear view monitor*

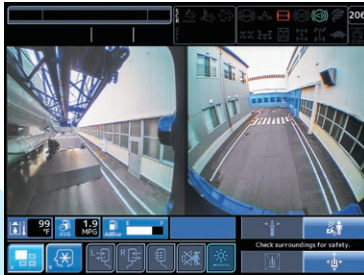

Rear view camera



Rear view monitor*



*The camera images in the photos are simulated.

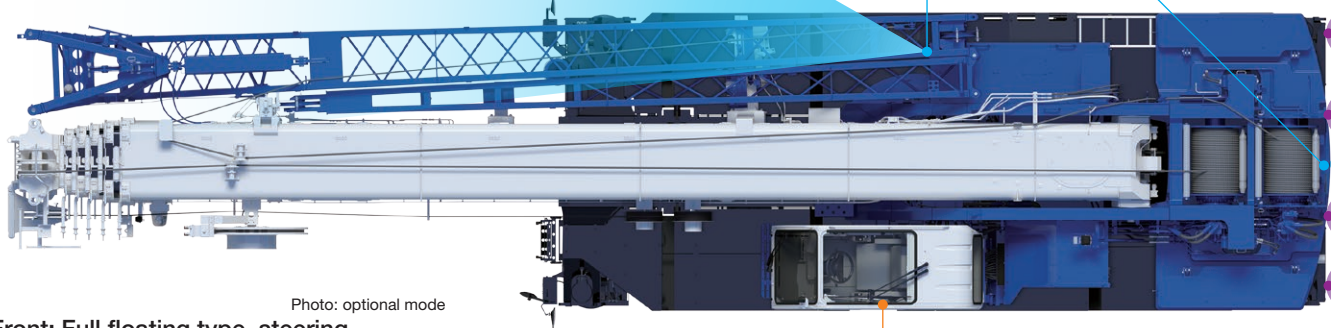

Photo: optional mode

Front: Full floating type, steering and driving axle with planetary reduction.

Rear: Full floating type, steering and driving axle with planetary reduction and non-spin rear differential.

Axle

Front: Full floating type, steering and driving axle with planetary reduction.

Rear: Full floating type, steering and driving axle with planetary reduction.

Improved Accessibility to Cab



New Designed Step
*Left side

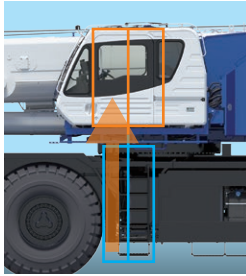

Clearance Sonar

Detects obstacles right behind the vehicle, and warns you with a flashing icon on the indicator and buzzer sound.

*Detection distance: approx. 1 ft – 8.5 ft (0.3 m – 2.6 m)



Clearance sonar monitor



Clearance sonar

Four Steering Modes

Hydraulic power steering controlled by steering wheel.

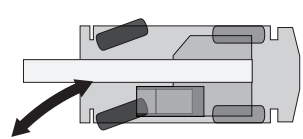

2 Wheel Front

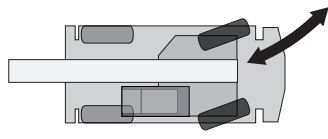

2 Wheel Rear

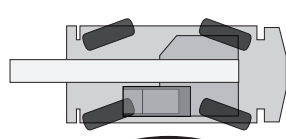

4 Wheel Coordinated

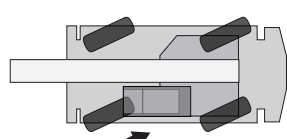

4 Wheel Crab

Dashboard Indicator and Warning Symbols

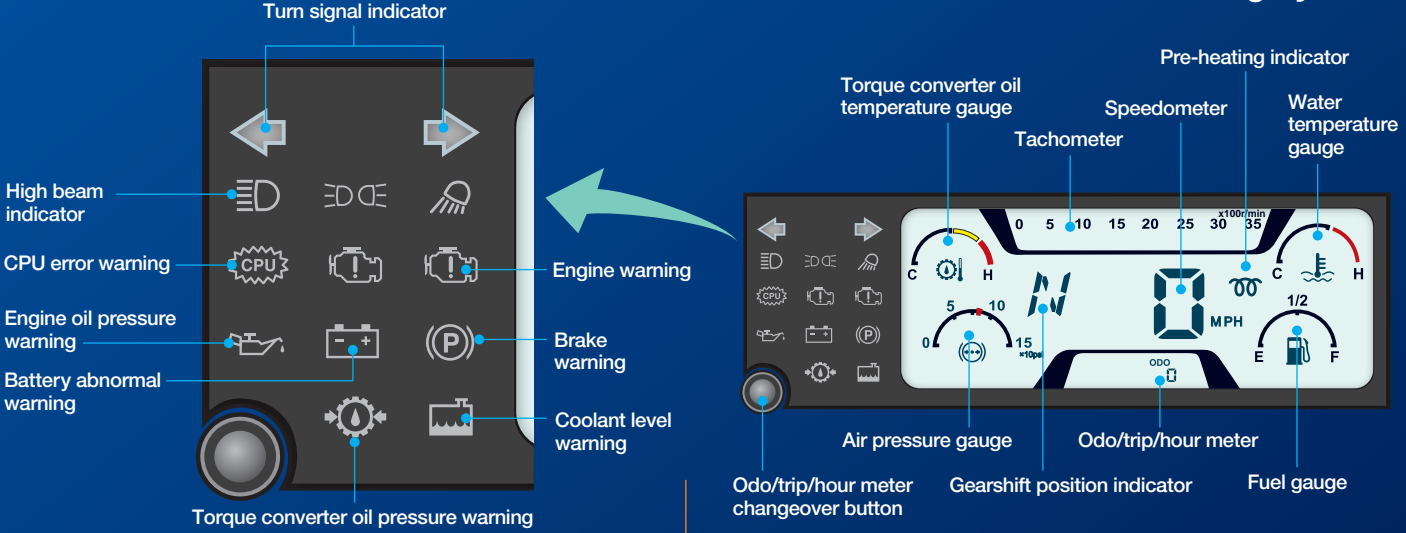

* The camera image in the photo are simulated.



Large multi-function display



Transmission shiftswitch

Cup holder

Efficient Transportability

2 axle carrier - light weight and compact size

28'10" carrier - including outrigger boxes (no more disassembly)

Most Efficient Transport with 2 Trailers

COUNTERWEIGHT: 43,500 lbs (19,800 kg)

GVW: 114,600 lbs (51,950 kg)

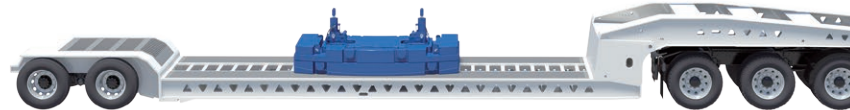
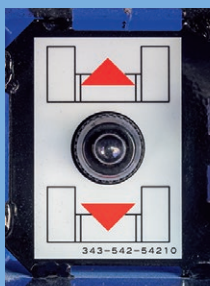

Photo: optional model

Mounting and Dismounting Systems



Self-Removable Counterweight

Counterweight is hydraulically mounted and dismantled; in addition, dismantled counterweights can be lifted and moved for transport, and then remounted for operation at a work site without a helper crane.

Counterweight mounting/dismounting remote controller



Counterweight mounting/dismounting cylinder



Reduced Fuel Consumption

Fuel Monitoring

Fuel consumption monitoring allows an operator to minimize fuel waste from unnecessary acceleration and idling.

The average fuel consumption is shown when your crane is operated. Fuel consumption during standby is automatically displayed when each control lever and pedal is in neutral position.

Fuel consumption during standby: 0.3 G

Average fuel consumption: 0.8 h/G



Preset menu display (during crane operation)

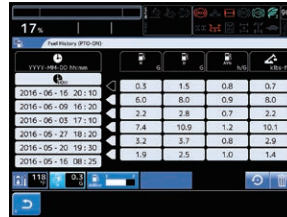

Fuel consumption history display (during crane operation)

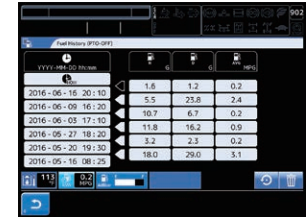

Fuel consumption history display (during traveling)

Positive Control System

Effectively controls the quantity of hydraulic pump discharge during crane operation in response to the amount of movement applied, and reduces CO₂ consumption.

Eco Mode System

Controls the maximum engine speed at the time of crane operation and enables fuel consumption and CO₂ emission to decrease by Max. 28% with Eco mode 1, and Max. 37% with Eco mode 2, and noise level is reduced.

Automatic Pump Disconnect

When the automatic pump disconnect switch is set to ON and the crane is not in use for a duration of time, the crane's hydraulic pump automatically shuts off, helping to reduce fuel consumption. Three settings are available for the duration of the crane operation standby before the pump shuts off: MIN, MID and MAX.

- MIN: 1 minute
- MID: 3 minutes
- MAX: 5 minutes

Fuel consumption
CO₂ emissions

Down
max.
12%

HELLO-NET

HELLO-NET is a tool that connects the crane operations with owners, their service staff and the manufacturer through satellite. This high quality telematic tool collects data of the crane including working history, maintenance data and machine location. HELLO-NET can be accessed by the manufacturer to assist with downtime and to help improve Tadano support services.



HELLO-NET Telematics - Available in the U.S. and Canada, other countries may vary. Contact your distributor or sales@tadano-cranes.com for details.

HELLO-DATA LINK

Smartphone App

HELLO-DATA LINK connects cranes to mobile devices by wireless LAN, allowing you to receive operating status, indications, error codes and other information in real-time from outside the cab.

HELLO-DATA LINK helps crane and site supervisors to monitor operating status and stay informed on repairs and maintenance.

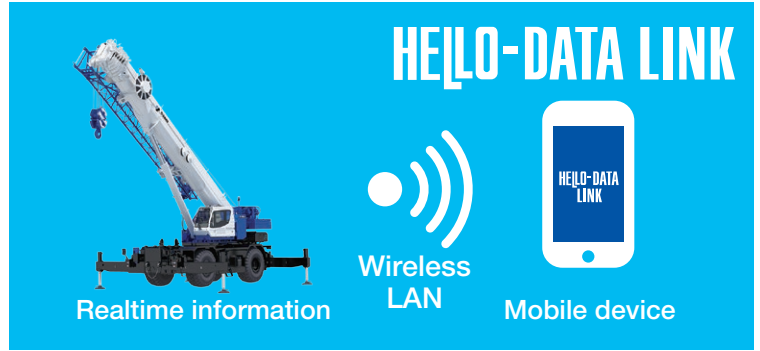

Four Working Displays

Display information from connected machines via handy smartphone or tablet.

Swipe to easily change screens.

*Available display modes and information may differ depending on machine model.

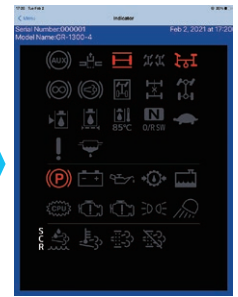
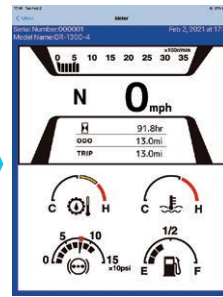
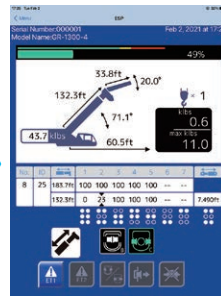
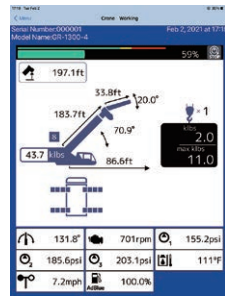

Standard Equipment

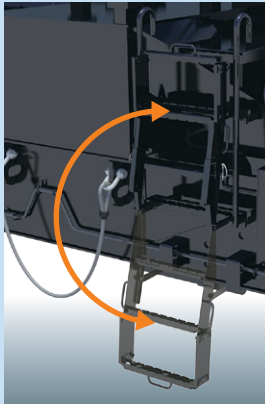

Front Steps

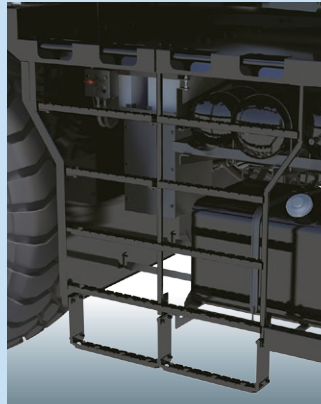

Right Side Steps



Rear Steps

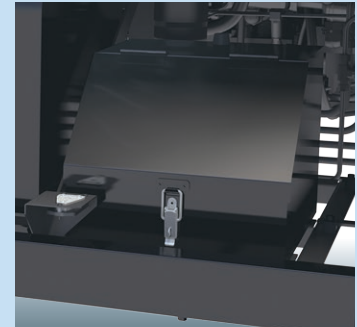

Tool Box



Battery Disconnect Switch



Work Light



DEF Tank



Data Logger (ISU)
USB Connection Port

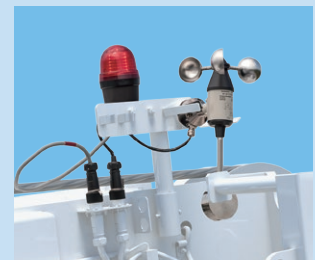

Aviation Obstruction
and Anemometer

MODEL: GR-1300XL-4

SPECIFICATIONS

MAXIMUM CAPACITY PERFORMANCE Max. traveling speed Gradeability (tan θ)	260,000 lbs at 8 ft (130 US ton at 2.4 m) 12 mph (19 km/h) 57% (at stall) * Machine should be operated within the limit of engine crankcase design (30°: Cummins B6.7)
WEIGHT Gross vehicle mass -1st axle -2nd axle	158,100 lbs (71,700 kg) 79,100 lbs (35,860 kg) 79,000 lbs (35,840 kg)
MIN. TURNING RADIUS	2-wheel steer: 44' (13.4 m) 4-wheel steer: 24' 7" (7.5 m) (at center of extreme outer tire)
BOOM Fully retracted length Fully extended length Extension speed Angle Elevation speed	6-section extended by single telescoping cylinder. 40.0' (12.2 m) 183.7' (56.0 m) 143.7' in 410 s -1.5°-81.5° 20' to 60' in 28 s
JIB Hydraulic offset Length	2 stage bi-fold lattice jib with hydraulic offset. Single sheave at the head of both jib sections. 5°-40° 33.8', 59.1' (10.3 m, 18.0 m)
MAIN WINCH Max. single line pull Single line speed Wire rope	Variable speed type with grooved drum driven by hydraulic axial piston motor. 15,900 lbs (7,200 kg) 446 fpm (136 m/min) (at 4th layer) 3/4" x 1,050' (19 mm x 320 m) (diameter x length)
AUXILIARY WINCH Max. single line pull Single line speed Wire rope	Variable speed type with grooved drum driven by hydraulic axial piston motor. 15,900 lbs (7,200 kg) 446 fpm (136 m/min) (at 4th layer) 3/4" x 738' (19 mm x 225 m) (diameter x length)
SLEWING Slewing speed Tail slewing radius	1.3 min ⁻¹ {rpm} 15'1" (4,600 mm)
HYDRAULIC SYSTEM	Pumps... 2 variable piston pumps for crane functions. Tandem gear pump for steering, slewing and other hydraulic systems. Control valves... Multiple valves actuated by pilot pressure with integral pressure relief valves. Reservoir... 210 gal. (795 lit.) capacity. External sight level gauge. Filtration... BETA10=10 return filter, full flow with bypass protection, located inside of hydraulic reservoir. Accessible for easy replacement. Oil cooler... Air cooled fan type.

TADANO Load Moment Indicator (TADANO AML-E2)	Following information is displayed: • Control lever lockout function with audible and visual pre-warning • Number of parts of line • Boom position indicator • Outrigger state indicator • Slewing angle • Boom angle / boom length / jib offset angle / jib length / load radius / rated lifting capacities / actual loads read out • Potential lifting height • Ratio of actual load moment to rated load moment indication • Automatic Speed reduction and slow stop function on boom elevation and slewing • Working condition register switch • Load radius / boom angle / tip height / slewing range preset function • External warning lamp • Tare function • Main Hydraulic oil pressure • Fuel consumption monitor • Main winch / auxiliary winch select • Drum rotation indicator (audible and visible type) main and auxiliary winch • On rubber indicator
OUTRIGGERS Extension widths	Four hydraulic, beam and jack outriggers. Vertical jack cylinders equipped with integral holding valve. Each outrigger beam and jack is controlled independently from cab. Max. ... 25' 7" (7.8 m), Mid. ... 18' 1/2" & 23' 11-3/8" (5.5 m & 7.3 m), Min. ... 9' 6-3/16" (2.9 m), Float size (Diameter)... 1' 10-1/2" (0.57 m)
CARRIER	Rear engine, left-hand steering, driving axle 2-way selected type by manual switch. 4 x 2 front drive, 4 x 4 front and rear drive.
ENGINE	Model... Cummins B6.7 Type... 4-cycle, turbo charged and after cooled, direct injection diesel. Piston displacement ... 408 cu. in. (6.7 liters) Bore x stroke... 4.212 in. x 4.882 in. (107 mm x 124 mm) Max. output... Gross 280 HP (209 kW) at 2,200 min ⁻¹ {rpm} Max. torque... 850 ft-lb (1,152 Nm) at 1,500 min ⁻¹ {rpm}
TRANSMISSION	Electronically controlled full automatic transmission.
STEERING	Hydraulic power steering controlled by steering wheel. Four steering modes available: 2-wheel front, 2-wheel rear, 4-wheel coordinated and 4 wheel crab
SUSPENSION	Front: Rigid mounted to frame. Rear : Pivot mounted with hydraulic lockout device.
TIRES	29.5R25☆☆ (OR) Air pressure: 94 psi (650 kPa) or 29.5-25 38PR (OR) Air pressure: 87 psi (600 kPa)
FUEL TANK CAPACITY	79.2 gal. (300 lit.)

WORKING RANGE

SMART CHART

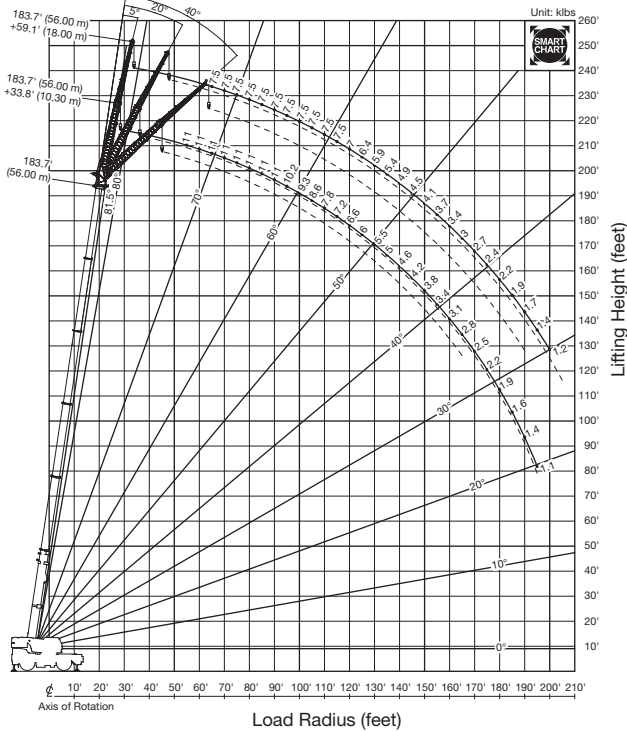

DIMENSION

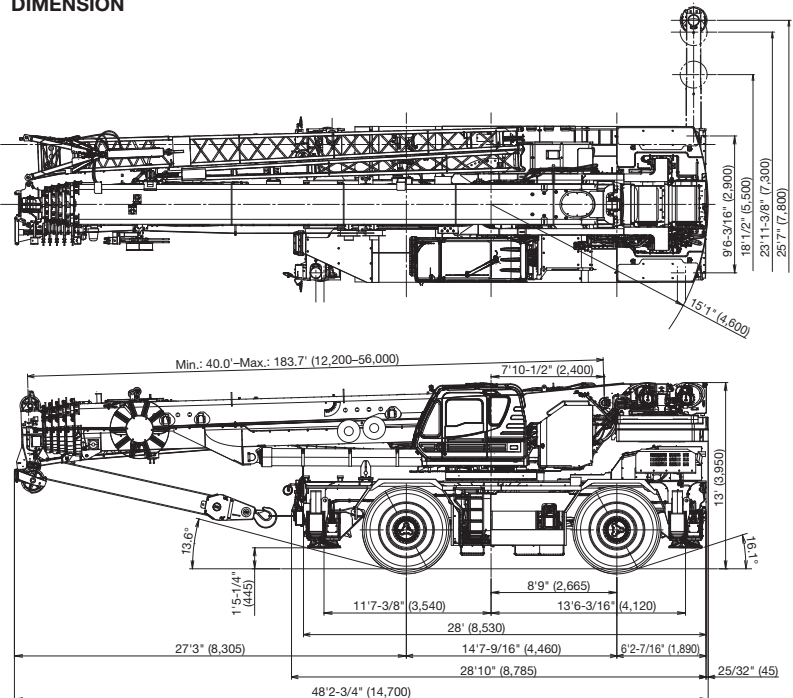

Note: Dimension is with boom angle at -1.5 degree.
() Reference dimensions in mm.

Note: Specifications are subject to change.



TADANO AMERICA CORPORATION

4242 West Greens Road, Houston, TX 77066

Tel: 281-869-0030 Fax: 281-869-0040

www.tadanoamerica.com

Parts Hotline: 713-865-1041 Service Hotline: 281-869-5925