

To learn more about this model, call 414-764-9200 or visit giuffre.com today!



BT 4792

**23.5 US t Lifting Capacity
Boom Truck Cranes
Datasheet
Imperial**

BT 4792



Features:

- ▶ 23.5 US t @ 5 ft capacity at rated distance from center of rotation
- ▶ 92 ft maximum boom length
- ▶ 26/44 ft optional jib
- ▶ 144 ft maximum sheave height with 44 ft jib
- ▶ Electronic rated capacity indicator
- ▶ Quick reeving boom head

WORKS FOR YOU.™



AVAILABLE AT:

GIUFFRE.COM

GIUFFRE BROS CRANES INC.

6635 SOUTH 13TH ST. - MILWAUKEE, WI 53221
414-764-9200 • 877-321-3710

CONTENTS

BT 4792

Page:

Key

.....	3
-------	---

Dimensions

Crane Dimensions	4, 5
Area of Operation	5
Mounting Specifications	5
Range Diagram	6

Load charts

Boom Load Chart	7
Jib, Retracted	7
Jib, Extended	7

Technical description



















Boom, Jib and Rotation	8
Operator Controls and Operator Aid	8, 9
Understructure	9
Optional Features	9



TEREX®

KEY

BT 4792

	Main boom		Main Hoist
	Boom length		Hoist line speed
	Tip height		Part line
	Telescoping mode		Operator aid
	Boom angle		Controls
	Working radius		Hydraulics
	Boom with jib		Working temperature
	Boom head		Outriggers
	Hook block		Working speeds
	Hook to head sheave pin		Rope – Standard / Optional
	Rotation / Allowable rotation range		Rope diameter
	Boom angle		Rope length
	Boom over the rear / BT 4792		Line pull
	Boom 360° / RM 4792		

To learn more about this model, call 414-764-9200 or visit giuffre.com today!

DIMENSIONS

BT 4792

Crane Dimensions

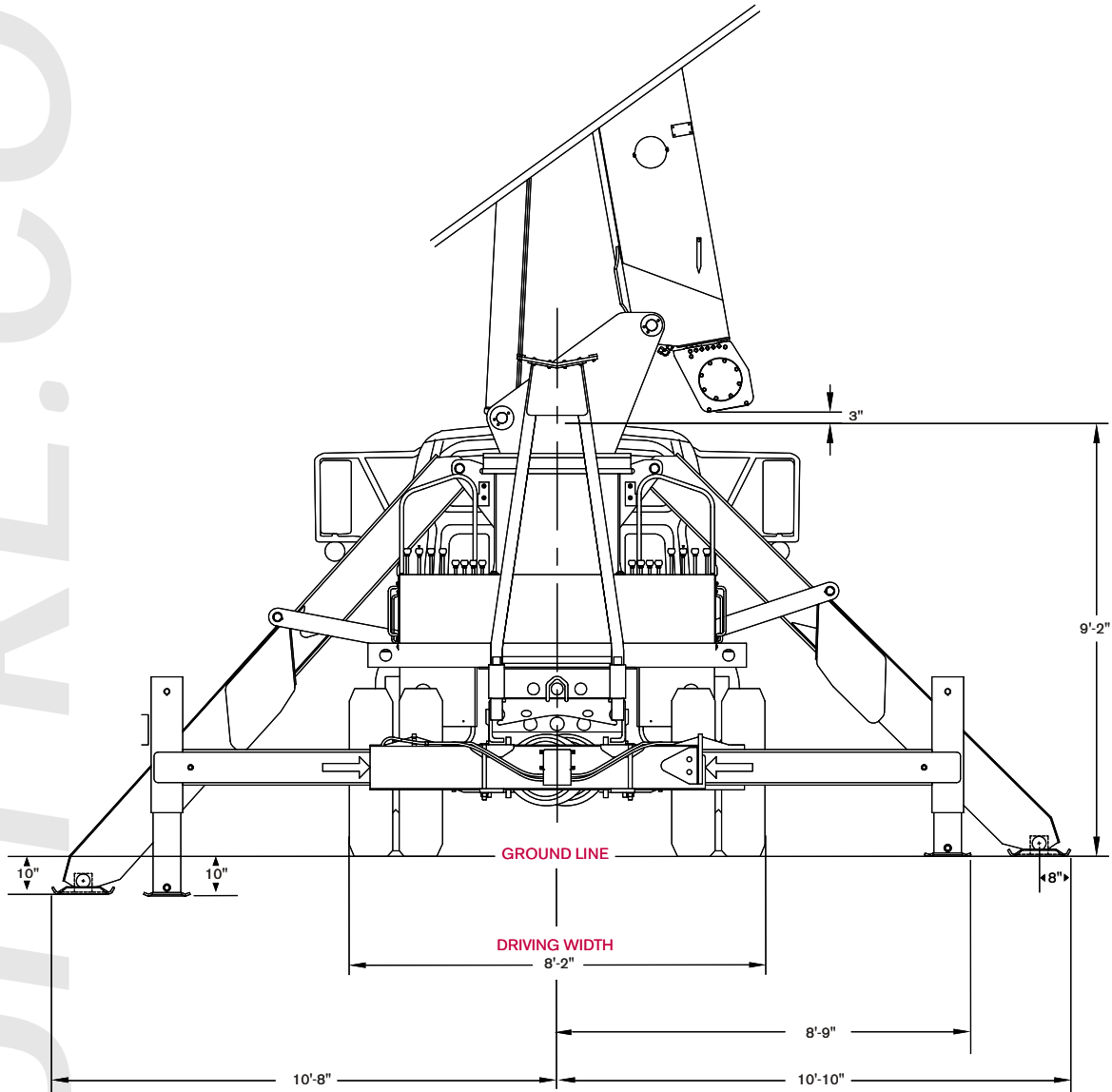

DIMENSIONS

BT 4792

Crane Dimensions

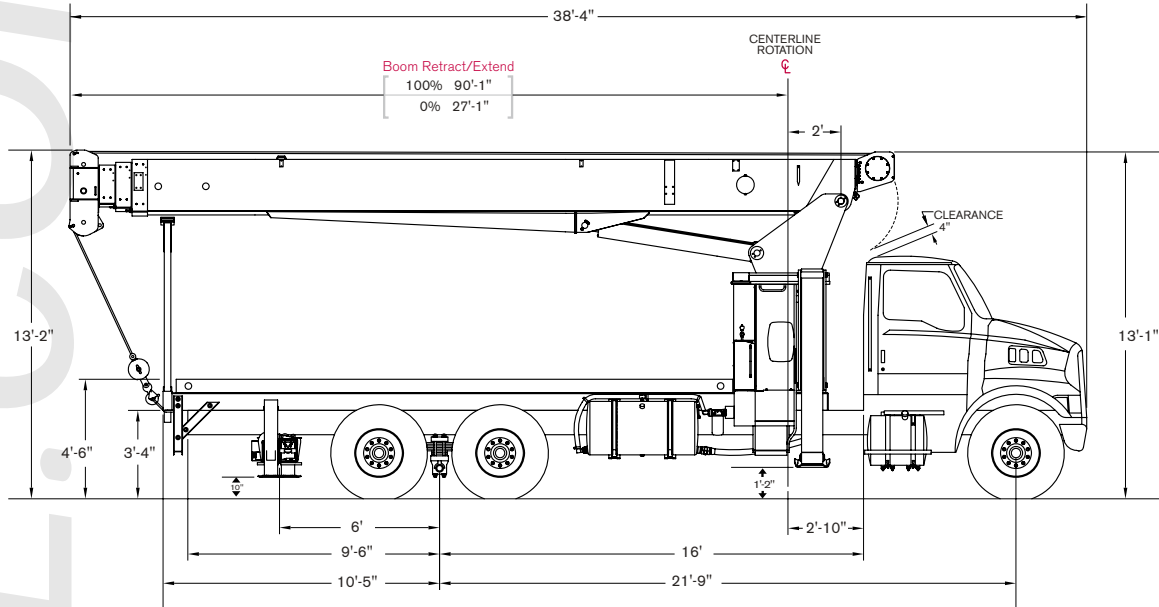

Area of Operation

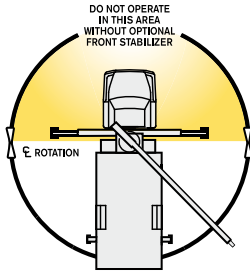

Mounting Specifications

Chassis Recommendation

Gross Vehicle Weight Rating	60,000 lb
Front Axle Weight Rating	20,000 lb
Rear Axle Weight Rating	40,000 lb
Crane weight	21,780 lbs
Wheelbase	260 +/- 8 in
Cab to Axle	192 +/- 6 in
Afterframe	114 +/- 4 in
RBM per Frame Rail	2,800,000 lb/in
Frame Height (Unloaded)	40 in
Exhaust	Horizontal Left Side

To learn more about this model, call 414-764-9200 or visit giuffre.com today!

RANGE DIAGRAM

BT 4792

Outriggers Fully Extended (100%)

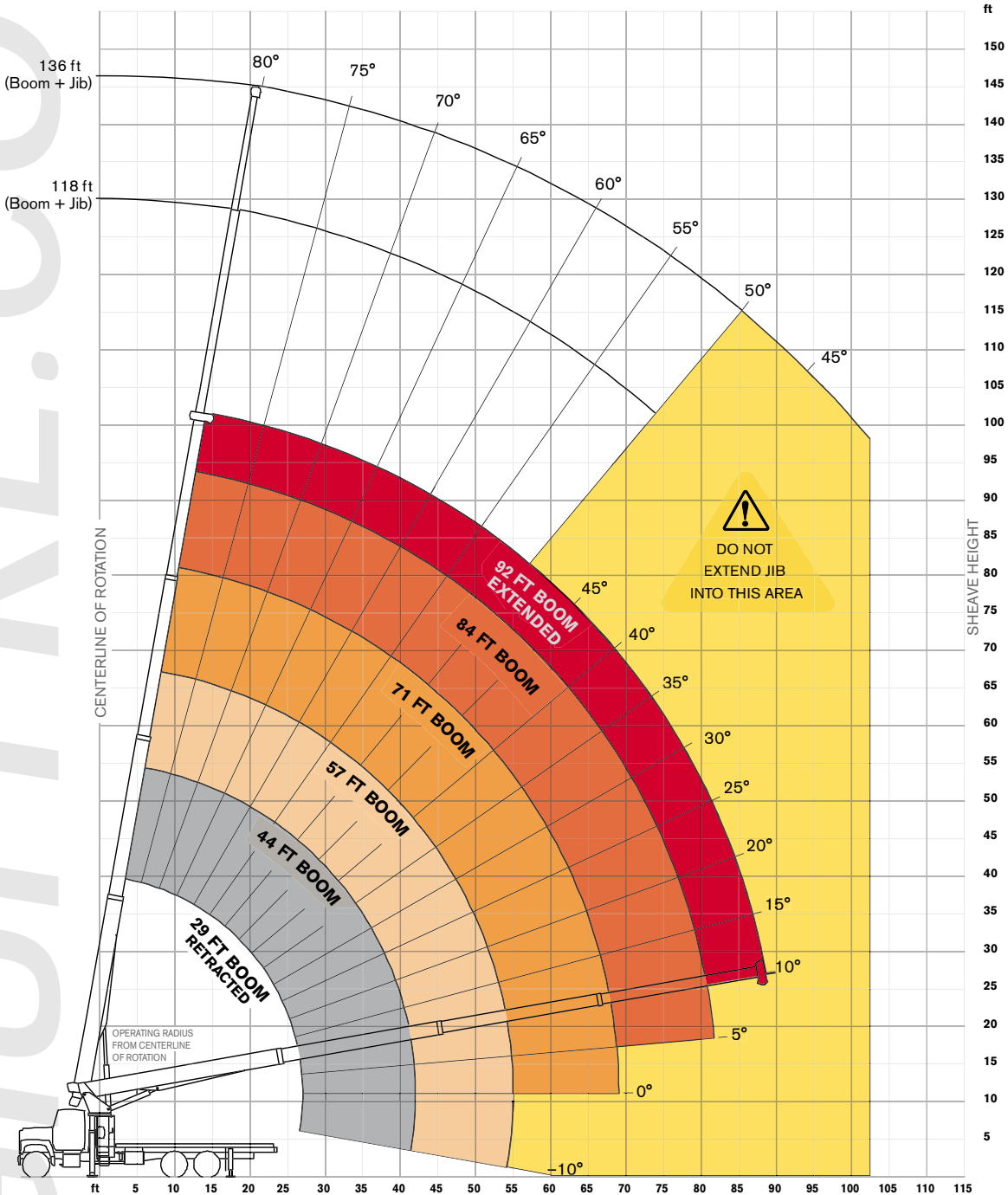

AVAILABLE AT:

GIUFFRE.COM

GIUFFRE BROS CRANES INC.

6635 SOUTH 13TH ST. - MILWAUKEE, WI 53221
414-764-9200 • 877-321-3710

BOOM LOAD CHARTS

BT 4792

Outriggers Fully Extended (100%)

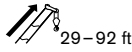

Standard ASME B30.5

ft	Boom Length						ft
	29	44	57	71	84	92	
lb	lb	lb	lb	lb	lb	lb	lb
5	47,000						
8	36,800	20,300					
10	30,900	20,300	18,400				
12	26,100	20,300	17,400				
14	21,900	19,400	16,800	14,600			
16	18,800	17,300	15,900	13,800	12,300		
20	14,200	13,900	13,400	12,300	10,900	9,825	
25	10,400	10,900	10,600	10,400	9,800	9,025	
30		8,625	8,625	8,425	8,225	7,425	
35		6,925	6,925	6,925	6,725	6,325	
40		5,225	5,625	5,625	5,625	5,425	
45			4,625	4,625	4,625	4,625	
50			3,725	3,725	3,725	3,725	
55			1,225	3,025	3,025	3,025	
60				2,425	2,425	2,425	
65				2,025	2,025	2,025	
70					1,525	1,525	
75					1,225	1,225	
80					825	825	

Boom at 0°

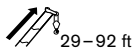

Standard ASME B30.5

°	Boom Length						°
	29	44	57	71	84	92	
lb	lb	lb	lb	lb	lb	lb	lb
0	7,500	4,000	1,225	1,100	650	550	

With Jib, Retracted and Extended

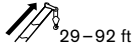

Standard ASME B30.5

ft	Jib Capacities for All Boom Lengths								ft
	50°	55°	60°	65°	70°	75°	78°	80°	
lb	lb	lb	lb	lb	lb	lb	lb	lb	lb
26	725	1,025	1,525	2,325	3,225	4,325	4,925	5,325	
44	425	725	1,125	1,525	2,025	2,525	2,825	3,125	

Notes to lifting capacity







Lifting capacities do not exceed 85% of tipping load. Weight of hook blocks and slings is part of the load, and is to be deducted from the capacity ratings. Consult operation manual for further details.

Note: Data published herein is intended as a guide only and shall not be construed to warrant applicability for lifting purposes. Crane operation is subject to the computer charts and operation manual both supplied with the crane.

TECHNICAL DESCRIPTION

BT 4792

Boom, Jib and Rotation

	Four-section full power fully synchronized telescopic keel boom	
	Boom length	92 ft
	Boom maximum sheave height	101 ft
	Boom elevation angle range (min/max)	-8° / 82°
	Boom up/down time	41/30 seconds
	Boom extension/retraction time	80/36 seconds
	Boom head	Quick reeving
	Maximum sheave height: With optional jib 26-44 ft	144 ft
	180 degree non-continuous rotation or optional 360 degree continuous rotation	

Operator Controls and Operator Aid

	Hoist line pull (1st layer)	11,400 lb
	Hoist line speed (3rd layer)	186 ft/min
	Rope diameter	9/16 in
	Breaking strength	33,600 lb
	Overhaul ball	7 US t
	1 Sheave block	17.5 US t



TECHNICAL DESCRIPTION

BT 4792



1 part line	10,500 lb / 186 ft/min
2 part line	21,000 lb / 93 ft/min
3 part line	31,500 lb / 62 ft/min
4 part line	34,000 lb / 45.5 ft/min



Fully proportional



Electronic rated capacity indicator

Understructure



Front: Link-type To outer edge of pad	21 ft 9 in
Rear: "H" pattern, (out and down) To outer edge of pad	17 ft 6 in

Optional Features

- Two-stage jib
- Rotation resistant rope
- Multi-part load blocks
- Main hoist with 2 speed motor
- Heavy duty wood flatbeds
- Extra heavy duty wood flatbeds
- Extra heavy duty steel flatbeds
- Radio remote controls
- One-man or two-man baskets
- Hoist drum tensioner
- Continuous rotation
- Oil cooler
- Single front bumper outrigger
- Hydraulic hose reel
- Tool box

To learn more about this model, call 414-764-9200 or visit giuffre.com today!

NOTES

BT 4792

GIUFFRE.COM

Lined area for notes.



AVAILABLE AT:

GIUFFRE.COM

GIUFFRE BROS CRANES INC.

6635 SOUTH 13TH ST. - MILWAUKEE, WI 53221
414-764-9200 • 877-321-3710

To learn more about this model, call 414-764-9200 or visit giuffre.com today!

NOTES

BT 4792

GIUFFRE.COM

Lined area for notes.



AVAILABLE AT:

GIUFFRE.COM

GIUFFRE BROS CRANES INC.

6635 SOUTH 13TH ST. - MILWAUKEE, WI 53221
414-764-9200 • 877-321-3710

To learn more about this model, call 414-764-9200 or visit giuffre.com today!

BT 4792

Effective Date: February 2014. Product specifications and prices are subject to change without notice or obligation. The photographs and/or drawings in this document are for illustrative purposes only. Refer to the appropriate Operator's Manual for instructions on the proper use of this equipment. Failure to follow the appropriate Operator's Manual when using our equipment or to otherwise act irresponsibly may result in serious injury or death. The only warranty applicable to our equipment is the standard written warranty applicable to the particular product and sale and Terex makes no other warranty, express or implied. Products and services listed may be trademarks, service marks or trade-names of Terex Corporation and/or its subsidiaries in the USA and other countries. All rights are reserved. Terex® is a registered trademark of Terex Corporation in the USA and many other countries.

Copyright 2014 Terex Corporation.

Terex Cranes, Global Marketing, Dinglerstraße 24, 66482 Zweibrücken, Germany
Tel. +49 (0) 6332 830, Email: info.cranes@terex.com, www.terexcranes.com



www.terexcranes.com

Brochure Reference: TC-DS-I-E-BT4792-02/14



TEREX®

WORKS FOR YOU.™



AVAILABLE AT:

GIUFFRE.COM

GIUFFRE BROS CRANES INC.

6635 SOUTH 13TH ST. - MILWAUKEE, WI 53221
414-764-9200 • 877-321-3710