



 **21,5 t**
 **40 t**
 **35 t**
F See Instruction manual



 **Peso de la grúa sin tren de transporte y sin lastre / Dead weight without transport axles and without ballast /**
Konstruktionsgewicht ohne transportachse ohne ballast / Poids de construction sans essieux et sans lest / Peso della gru senza assali e senza zavorra
 **Peso de lastre / Ballast weight / Ballastgewicht / Poids du lest / Peso zavorra rotante**
*** Peso de lastre de montaje / Ballast weight of erection / Ballastgewicht / Poids du lest de montage / Peso zavorra rotante di montaggio**

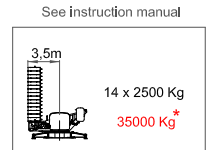
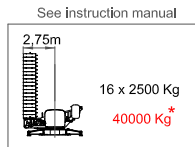

DIN/FEM 

EN 14439-FEM 1005- C25



Curvas de cargas - Load diagrams - Lastkurven - Courbes de charges - Curve di carico - График грузоподъёмности

SUPER LIFT





H

JIB	12,7	13,6	14	15,7	17,5	18	20	22	24	26	28	30	32	33,5	38,5	41,5	45	47	m
47	6000	5707	5520	4835	4241	4114	3641	3260	2945	2685	2472	2280	2117	2010	1705	1580	1417	1360	Kg
45	6000	6000	5930	5160	4535	4400	3905	3504	3175	2903	2671	2471	2300	2183	1865	1700	1570	Kg	
41,5	6000	6000	5810	5565	4920	4620	4305	3775	3443	3170	3100	2710	2575	2445	2095	1885	Kg		
38,5	6000	6000	6000	6000	5360	5203	4625	4165	3785	3465	3200	2965	2765	2635	2265	Kg			
33,5	6000	6000	6000	6000	6000	5940	5315	4815	4405	4060	3765	3515	3300	3152	Kg				



JIB	12,7	13,6	14	15,7	17,5	18	20	22	24	26	28	30	32	33,5	38,5	41,5	45	47	m
47 m	6000	5510	5320	4640	4047	3920	3450	3070	2760	2500	2290	2100	1940	1833	1535	1410	1254	1200	Kg
45 m	6000	6000	5800	5056	4416	4276	3770	3360	3025	2750	2511	2308	2133	2016	1694	1530	1400	Kg	
42 m	6000	6000	5720	5540	4830	4520	4155	3600	3250	2965	2875	2490	2350	2220	1870	1670	Kg		
38,5	6000	6000	6000	6000	5248	5084	4485	4007	3615	3285	3010	2772	2565	2430	2050	Kg			
33,5	6000	6000	6000	6000	6000	5814	5135	4590	4145	3775	3460	3190	2956	2800	Kg				

Mecanismos - Mechanisms - Antriebe - Mécanismes - Meccanismi - Приводы

20Hp (15Kw) INV
400V 50-60Hz

	m/min	12	25	45	65
	Kg	6000	3000	1500	500
	Kw	15			
	m/min	15	35	50	
	Kw	4,5			
	r.p.m	0,25	0,5	0,8	
	N.m.	30			
	Kw	9			

20Hp (15Kw) - INV

 2000/14/CEE 2005/88/CEE	 2006/95 /CEE	400V 50Hz I _{max} = 72A Fuse= 80A	480V 60Hz I _{max} = 60A Fuse= 70A	TOTAL POWER 22 KVA	GENERATOR 75 KVA	100m 4x25mm ²	150m 4x35mm ²	200m 4x35mm ²
---	--	--	--	-----------------------	---------------------	-----------------------------	-----------------------------	-----------------------------





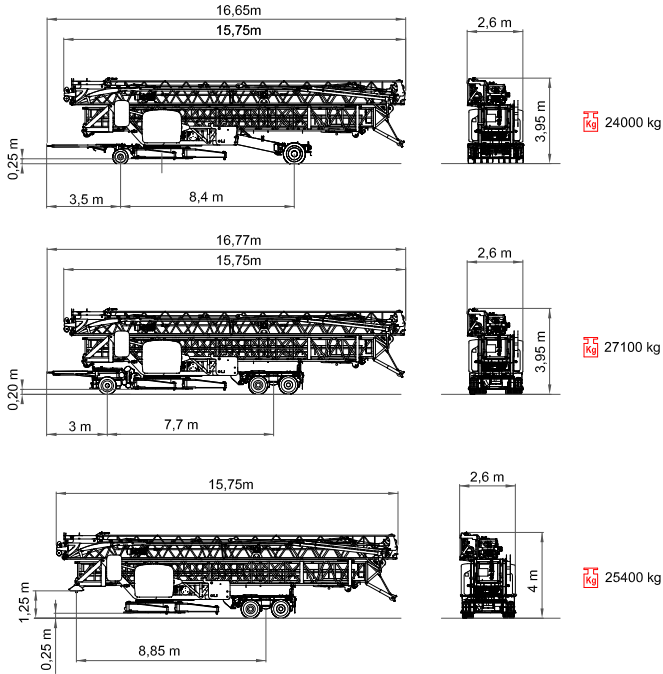



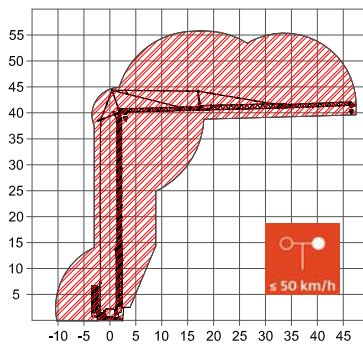







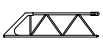



-  Elevación / Hoisting / Heben / Levage / Sollevamento
-  Distribución / Trolleying / Katzfahren / Distribution / Distribuzione
-  Orientación / Slewing / Schwenken / Orientation / Rotazione
-  Montaje / Erection / Montage / Montaggio

Dimensiones y transporte - dimensions and transport - Abmessungen und Transport- dimensions et des transporte - dimensioni e trasporti - Размеры и транспорта



Montaje - Erection - Montage - Montage - Montaggio



			L (m)	X (m)	Y (m)	kg			
Pos. Item	Anz. Qty.	Rep. Voce							
Ref.	Cant.	Cant.							
1	4	Tramo de torre / Tower section/ Turmstück			2,4 m	0,94 m	1 m	485	
2	2	Elément de mat / Elemento di torre			2,4 m		560		
3	1	Prolongación de pluma (T3.1) / Jib extension / Rallón de la fleche / Elemeto estensione braccio/ Ausleger-Verlängerung			5,47 m	0,8 m	0,7 m	305	
4	1	Prolongación de pluma (T3.2) / Jib extension / Rallón de la fleche / Elemeto estensione braccio/ Ausleger-Verlängerung			5,47 m	0,8 m	0,69 m	235	
5	1	Prolongación de pluma (T3.3) / Jib extension / Rallón de la fleche / Elemeto estensione braccio/ Ausleger-Verlängerung			2,6 m	0,8 m	0,69 m	105	
6	1	Eje delantero para transporte / Road transport axle front Essieux de transport avant / Asse di trasporto anteriore Transportachse vorne			3,55	4,15 m	1,15 m	1,10 m	935
7	1	Eje delantero para transporte / Road transport axle front Essieux de transport avant / Asse di trasporto anteriore Transportachse vorne			3,8 m	2,5 m	1,30 m	1920	
8	1	Eje trasero para transporte / Road transport axle behind Essieux de transport avant / Asse di trasporto posteriore Transportachse hinten			1,90 m	2,5 m	1,05 m	1100	
9	1	Eje trasero para transporte / Road transport axle behind Essieux de transport avant / Asse di trasporto posteriore Transportachse hinten			3,10 m	2,5 m	1,10 m	1920	
10	1	Eje trasero para transporte / Road transport axle behind Essieux de transport avant / Asse di trasporto posteriore Transportachse hinten			3,00 m	2,5 m	1,20 m	2550	
11	1	Eje trasero para transporte / Road transport axle behind Essieux de transport avant / Asse di trasporto posteriore Transportachse hinten			3,00 m	2,5 m	1,20 m	3000	