

IC-200-3J **Industrial Crane**

The IC-200 is a self-propelled Industrial crane designed for material handling and installation, and equipment maintenance. It includes a 4-section proportional hydraulically extended boom.

Capacity

30,000 lbs. (13,600 kg)

Sheave Height

73' 8" (22.5 m)
(with boom extension)

Horizontal Reach

66' (20.1 m)
(with boom extension)

Height

8' (2.44 m)

Width

7' 10.5" (2.4 m)



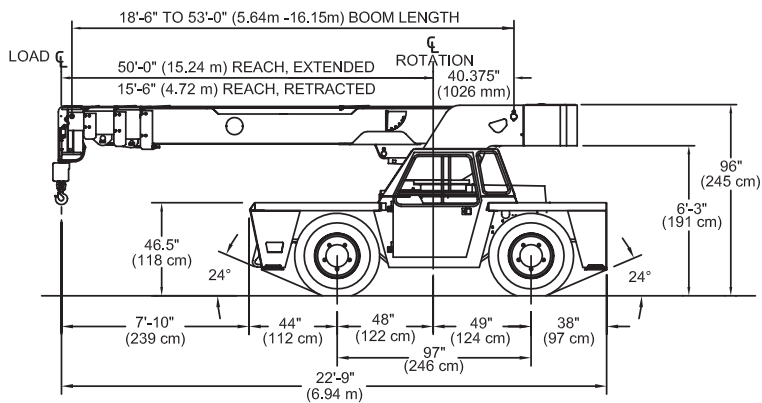
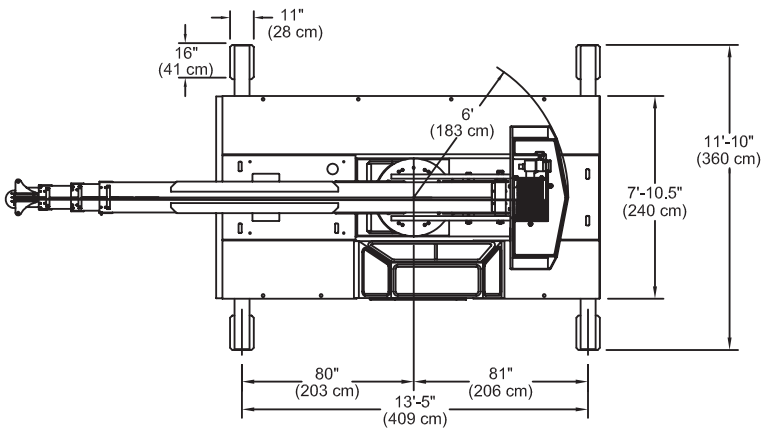
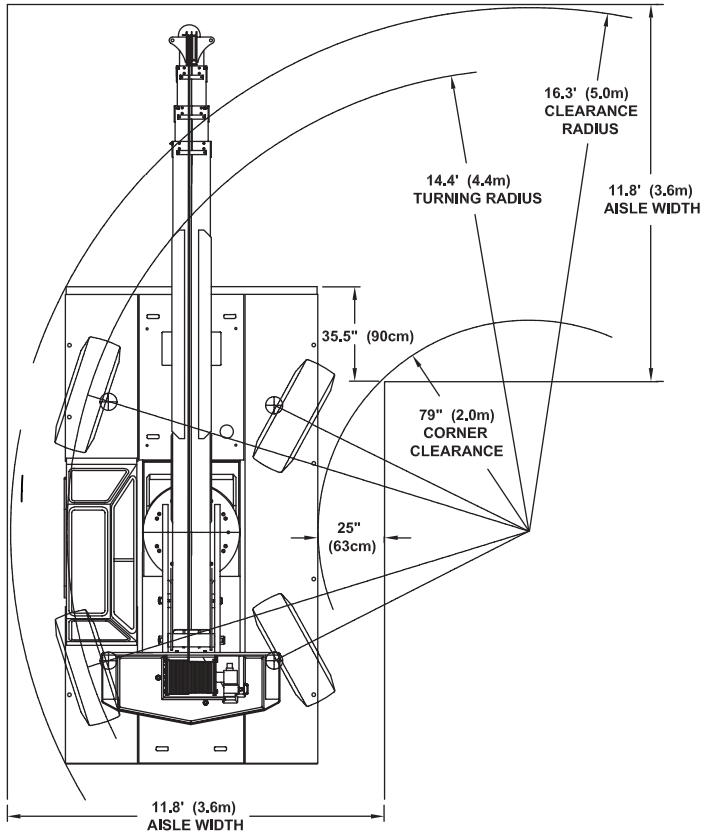

58'-8" (17.9 m) EXTENDED
25'-8" (7.8m) RETRACTED

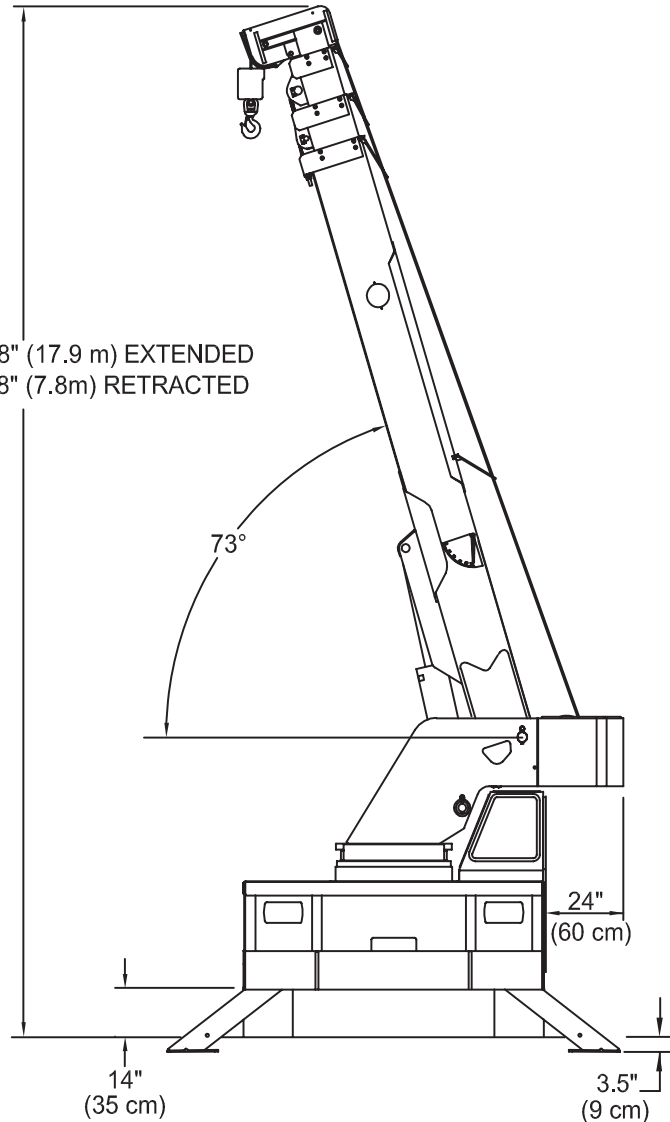

IC-200-3J

GENERAL SPECIFICATIONS



GENERAL

	ROTATION	ELEVATION	EXTENSION
Boom Movement	Continuous	0° to 73°	34'6" (10.5m)
Boom Speeds	1.8 RPM	20 sec.	50 sec.

Weight Total	31,080 lbs. (14,110 kg.)		
Gradeability	54% (28°)		
Turning Radius	14' 5" (4.42m)		

ENGINE

Make	GM	Cummins
Model	4.3L V6	QSF3.8L US EPA T4F
Type	Dual fuel with catalytic converter	Turbo-Diesel
Cylinder	6	4
Displacement	4.3L	3.8L
HP @ Gov. Speed	93HP (69kW)	120HP (89kW)

TRANSMISSION

POWERSHIFT TRANSMISSION with 4-speeds forward and reverse. Provides powershifts at any engine speed in any gear. All shifting is done with a single lever electrical control mounted on the steering column. Equipped with torque converter and transmission oil cooler. Torque converter has stall ratio of 2.2:1.

GEAR RATIO:

First - 5.72:1, Second - 3.23:1, Third - 1.77:1, Fourth - 1.00:1

FRONT

Planetary drive/steer front axle with 15.78 to 1.0 ratio. Differential equipped with "limited slip" feature. Front axle mounted rigidly to frame.

TRANS. GEAR	SPEED	DRAWBAR PULL*
First	3 MPH	17,000*
Second	5 MPH	8,900*
Third	10 MPH	5,100*
Fourth	18 MPH	2,700*

*Drawbar pull is calculated for GM 4.3L engine.

REAR

Standard (2-Wheel Drive):

Steering axle with 1-1/2 degree oscillation in either direction.

Optional (4-Wheel Drive):

Planetary drive/steer axle with 24.98 to 1.0 ratio. Differential is not "limited slip" in rear axle. 1-1/2 degree oscillation in either direction. Axle ratio compatible with 4-wheel drive transmission output for front axle match. Transmission equipped with electrohydraulic control for shifting between 2-wheel drive and 4-wheel drive.

AXLES

Full hydraulic steering unit with two 3-inch (7.6 cm) cylinders attached to each axle. Allows limited steering when engine is not running. A switch on the control panel is used to select rear-wheel steering, four-wheel steering or crab steering. Electronic sensors and control box automatically align the steering when a new mode is selected.

STEERING

Service: Split-system, 4-wheel hydraulic-boosted multiple plate wet disc brakes.

Parking: Hand lever actuated disc-type parking brake on transmission.

BRAKES

TIRES

15x22.5, 16-ply rating.

OPERATOR COMPARTMENT

Provides one-position access to all chassis & crane functions. Includes adjustable operator's seat, retracting seat belts, fire extinguisher & bubble level.

CHASSIS

CARGO DECK

66 square feet (6 m²) of deck area. 17,000 lbs (7,700 kg) capacity on deck when load is centered over or between axles. Steps located on front corners.

LIFTING RINGS

Lifting rings at each corner of cargo deck so sling can be attached for lifting crane.

OUTRIGGERS

Four hydraulic outriggers of box beam construction with direct connected holding valves. Independent controls for each outrigger.

Outrigger pad dimension: 11" x 16" (28cm x 41cm).

HEADLIGHT & TAILLIGHT GRILLES

Welded steel protective grilles for headlights and taillights.

ACCESSORY STORAGE BOX

Storage box is 14" (35cm) deep x 10-1/2" (26cm) long x 36-1/2" (93cm) wide, located in front cargo deck.

LIGHTING PACKAGE

One pair headlights with high and low beams, tail, brake and turn signal lights and back-up lights in rear, front turn signals and emergency flasher switch at operator's station.

DISPLAY

Fuel gauge and hourmeter records hours only during actual engine operations. Also includes warning lights for low oil and transmission pressure, check engine, high coolant and transmission temperature, turn signals, high beams, hazard lights, parking brake and four-wheel drive.

BACK-UP ALARM

Provides pulsating sound when transmission is in reverse.

OUTRIGGER ALARM SYSTEM

Two-tone alarm is activated when "outrigger down" controls are operated.

ELECTRICAL (12-VOLT SYSTEM)

HYDRAULIC

TANDEM PUMP direct-driven by engine crankshaft, rated at 29 GPM (110 L/min) and 34 GPM (129 L/min) at rated RPM. Hydraulic oil tank capacity of 54 gallons (204 L)..

FOUR-SECTION BOOM ASSEMBLY

equipped with bearing pads, double-acting hydraulic cylinders with direct-connected holding valves and boom angle indicator on each side of boom.

BOOM ROTATION

Heavy-duty ball bearing rotation gear with external teeth. Rotation is powered by hydraulic motor and worm gear drive.

BOOM HOIST

Turret mounted planetary gear hoist hydraulically powered with a bare drum line pull of 10,000 lbs. (4536 kg) at a line speed of 100 FPM (30 m/min). Includes downhaul weight, swivel hook and sheave block for 4-part line.

ANTI-TWO-BLOCK DEVICE

Prevents damage to hoist rope and/or crane components from pulling load hook against tip.

SHEAVE BLOCK, FOUR PART LINE

Double sheave block for 4-part line requirements.

RATED CAPACITY LIMITER

Warns operator of impending overload with audible & visual signals. Prevents overload by stopping boom functions that cause overloads.

DRUM ROTATION INDICATOR

Tactile feedback to operator when drum is rotating.

OTHER

Shorter boom model IC-200-2J available.

CONSULT THE IC-200-J ENGINEERING SPEC FOR ADDITIONAL INFORMATION.

Main Features

RATED CAPACITY LIMITER
Standard

CAPACITY ON OUTRIGGERS
30,000 lbs. (13,600 kg)

PICK AND CARRY CAPACITY
up to 17,000 lbs. (7,711 kg)

HEIGHT
8' (2.45 m)

WIDTH
7' 10.5" (2.4 m)

BOOM ROTATION
360° Continuous

SHEAVE HEIGHT
up to 73'10" (22.5 m)

HORIZONTAL REACH
up to 66' (20.1 m)

FOUR-WHEEL STEER
Standard

FOUR-WHEEL DRIVE
Optional

POWERSHIFT TRANSMISSION
Standard

**FULLY HYDRAULIC CONTROLS FOR
SMOOTH, PRECISE OPERATIONS**

**INDEPENDENT OUTRIGGER
CONTROLS**

**DIESEL OR DUAL FUEL ENGINES
AVAILABLE**

ENGINE

Spark Arrester Muffler

Installed in addition to standard muffler.
(Dual Fuel engine only.)

Engine Heater

Engine coolant heater installed to circulate warm water through engine, plugs into 120 volt AC.

AXLE & STEERING

4-Wheel Steer & 2-Wheel Drive
4-Wheel Steer & 4-Wheel Drive

TIRE

Non Marking Tires
Foam Filling of Tires
Spare Tire & Wheel

CHASSIS

Auxiliary Winch
Mounted behind the front bumper, hydraulically driven with control in operator's console.

Pintle Hook

Rear and Front

Rearview Mirrors

One mounted on right-hand deck stake and one mounted on left-hand deck stake.

OPERATOR COMPARTMENT

Operator Guard

Tubular steel weldment with heavy expanded steel mesh top section for units without All Weather Cabs.

All Weather Cab

Rigid-mounted canopy section and removable hinged door. Includes heater, electric windshield wiper, one sliding glass window in the door, & one in the right side of the canopy. Defroster fan & dome light included.

Cab Heater Only

Heater with two-speed fan for units without All Weather Cab.

Options

Windshield Washer

Includes reservoir, pump & nozzle.

Floor Mat

Vinyl mat with foam backing.

Operator Suspension Seat

Noise Reduction Kit

Includes floor mat, control valve cover and side panels of foam backed vinyl for noise reduction.

Air Conditioning

Air Conditioner w/134 coolant.

ELECTRICAL

Strobe Lights

Yellow strobe light mounted on each side of turret weight box.

Boom Work Lights

One work light mounted to boom to light boom tip and one work light mounted to turret to light ground under boom tip.

Work Lights - Rear

Two work lights recessed in rear bumper

RCL Light Bar

3 color light bar for external indication of load status

BOOM ATTACHMENTS

Boom Extension

16 foot (5 m), offsettable

Sheave Block

Two-Part Line

Searcher Hook

Nose Mount 5,000 lb (2,268 kg) capacity hook bracket

Broderson Cranes are manufactured to ISO 9001:2015 certified standards and have a market leading reputation for quality and reliability. Broderson Cranes are engineered for operating efficiency and are easy to operate and maintain.

An extensive network of full-service dealers offer parts and service support by factory-trained technicians.

For additional options or special equipment not listed, please consult your dealer salesperson or contact Broderson Manufacturing Corp.

BRODERSON[®]
Manufacturing Corp.
14741 West 106th Street
Lenexa, KS 66215 USA

(913) 888-0606
www.BMCcranes.com

Dimensions and values shown are for reference purposes only. Specifications subject to change.

