



TEREX T 500 SERIES Truck Cranes



FEATURES

- **50 ton (45 mt)**
maximum lifting capacity
- **110 ft. (33.5 m)**
maximum boom length
- **169 ft. (51.5 m)**
maximum tip height
- Four-section full power, mechanically synchronized boom with single lever control
- Swingaway jib offsettable 0°, 15° or 30°
- Two-speed main and auxiliary winches
- Quick-reeving boom head and hook block
- Fully independent multi-position out and down outriggers
- Environmental operator's cab optimizes load visibility and productivity
- RCI 500 load system Rated Capacity Indicator
- Travel speeds to 65 mph (105 km/h)
- Air suspension standard on front axles, optional on rear
- Easy to read load chart books include range diagrams
- 12-month or 2000 hours warranty, major weldments are 5-years or 10,000 hours

simple, available and
cost effective™

Machines shown may have optional equipment.

Courtesy of Crane.Market

TEREX T 500 SERIES

Truck Cranes

T 500 – 50 tons (45 mt)

110-ft. (33.5 m) FOUR-SECTION, FULL-POWER, MECHANICALLY SYNCHRONIZED BOOM WITH SINGLE LEVER CONTROL

- High strength, four plate construction welded inside and out with embossed side plate holes to reduce weight and increase strength.
- Single boom hoist cylinder provides boom elevation of -4° to 76° for easier reeving changes and close radius operation.
- Quick-reeving boom head; no need to remove wedge from socket.
- 360° house lock standard.

ENVIRONMENTAL OPERATOR'S CAB

- Rated Capacity Indicator (RCI) system including anti-two block system with automatic function disconnects.
- Deluxe six-way adjustable operator's seat has torsion bar suspension and adjustable head and arm rests.
- Sound and weather insulated for comfort.
- Removable front window, hinged tinted glass skylight, and sliding right-hand window.
- Hand operated control levers for swing, boom telescope, boom hoist, and single lever two-speed main winch; foot control pedals for swing brake and boom raise, boom lower, and throttle.
- Complete instrumentation. Environmentally-sealed rocker switches. Circuit breakers in cab.

RUGGED, EASY-TO-MANEUVER CARRIER

- Chassis is Terex designed and built with 8 x 4 drive.
- Full aluminum decking reduces weight.
- Multiple lockable storage compartments and optional ground level outrigger controls are built into decking.
- 10 speed manual transmission standard, CEEMAT automatic transmission optional.
- Air suspension standard on front axles, optional on rear axles.
- Full air brakes on all wheels with split circuit system.
- Fully independent hydraulic outriggers may be utilized fully extended to 21 ft. (6.40 m), in their 1/2 extended position, or fully retracted.
- Standard Detroit Diesel Series 50 engine.
- Tachometer and aluminum rims standard.

POWERFUL, TWO-SPEED WINCHES

- 533 fpm (162 m/min) maximum line speed, 15,639 lbs. (7093 kg) maximum line pull. Single lever control.
- Integral automatic brake.
- Electronic drum indicators.
- Winch drum rollers, tapered drum flanges.



HIGH CAPACITY, DEPENDABLE HYDRAULIC SYSTEM

- Three gear pumps driven from engine flywheel housing PTO. Combined system capability is 115 gpm (435 lpm).
- Hydraulic reservoir with 114 gal. (443 l) capacity and full flow oil filtration system.

OPTIONS INCLUDE:

- 32 ft. or 33 to 57 ft. (9.68 or 10.15 to 17.30 m) swing-on jib. Both offset 0°, 15° or 30°.
- Auxiliary winch with rope.
- Heater/defroster, air conditioner for operator's cab; air conditioner for carrier cab.
- Heavy counterweight package with hydraulic removal system.
- Cold weather kit for carrier cab.
- Detroit Diesel Series 60 engine.

For more information, product demonstration, or details on purchase, lease and rental plans, please contact your local Terex Cranes Distributor.

We reserve the right to amend these specifications at any time without notice. The only warranty applicable is our standard written warranty applicable to the particular product and sale. We make no other warranty, expressed or implied.

 **TEREX CRANES**

106 12th Street S.E.
Waverly, IA 50677-9466 USA
(319) 352-3920 • FAX: (319) 352-5727
E-mail: waverly@terexlifting.com

www.terexlift.com



TEREX T 500 SERIES

truck cranes
specifications

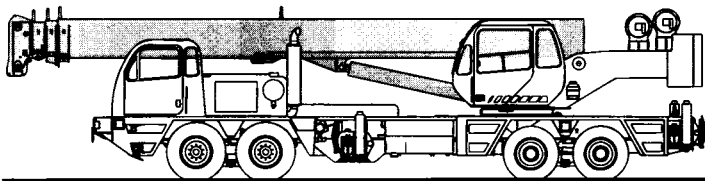

STANDARD BOOM EQUIPMENT

BOOM

35-110 ft. (10.67-33.53 m), four section full power, mechanically synchronized boom. High-strength four plate construction with embossed side plate holes to reduce weight and increase strength. Anti-friction slide pads. A single boom hoist cylinder provides for boom elevation of -4 to 76 degrees. Maximum tip height is 114 ft. (30.17 m).

BOOM HEAD

Welded to outer section of boom. Four or five load sheaves and two idler sheaves mounted on heavy duty, anti-friction bearings. Quick reeving boom head. Provisions made for side-stow jib mounting.

OPTIONAL BOOM EQUIPMENT

JIBS

32 ft. (9.75 m) side stow swing-on one-piece lattice type jib. Single sheave mounted on anti-friction bearing. Jib is offsettable at 0°, 15°, or 30°. Maximum tip height is 145 ft. (44.22 m) with 110 ft. (33.53 m) boom.

32-57 ft. (9.75-17.37 m) side stow swing-on lattice type jib. Single sheave mounted on anti-friction bearing. Jib is extendible to 57 ft. (17.37 m) by means of a 25 ft. (7.62 m) manual pull-out tip section, roller supported for ease of extension. Jib is offsettable at 0°, 15°, or 30°. Maximum tip height is 169 ft. (51.62 m) with 110 ft. (33.53 m) boom.

AUXILIARY BOOM HEAD

Removable auxiliary boom head has single sheave mounted on anti-friction bearing. Removable pin-type rope guard for quick reeving. Installs on main boom peak only. Removal is not required for jib use.

HOOK BLOCK

Three, or four nylon sheaves on anti-friction bearings with hook and heavy duty hook latch. Quick reeving design does not require removal of wedge and socket from rope.

HOOK & BALL

7 ton (6.3 mt) top swivel ball with hook and hook latch.

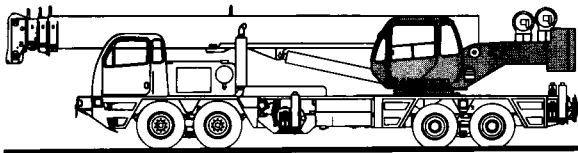

STANDARD UPPERSTRUCTURE EQUIPMENT

UPPERSTRUCTURE FRAME

All welded one-piece structure fabricated with high tensile strength alloy steel.

COUNTERWEIGHT

Counterweight is bolted to frame. Optional integral counterweight removal system permits counterweight to be carried on the deck of the carrier to optimize axle weights and multiple counterweight combinations to be utilized.

TURNTABLE CONNECTION

Swing bearing is a single row, ball type, with external teeth. The swing bearing is bolted to the revolving upperstructure and welded to the carrier frame.

SWING

A hydraulic motor drives a double planetary reduction gear for precise and smooth swing function. Swing speed (no load) is 2.8 rpm.

SWING BRAKE

Heavy duty multiple disc swing brake is mechanically actuated from operator's cab by foot pedal. Brake may be locked on or used as a momentary brake.

RATED CAPACITY INDICATOR

Rated Capacity Indicator with visual and audible warning system and automatic function disconnects. Pictographic display includes: boom radius, boom angle, boom length, allowable load, actual load, and percentage of allowable load registered by bar graph. Operator settable alarms provided for swing angle, boom length, boom angle, tip height, and work area exclusion zone. Anti-two block system includes audio/visual warning and automatic function disconnects.

OPERATOR'S CAB

Environmental cab with all steel construction, optimum visibility, tinted safety glass throughout, and rubber floor matting is mounted on vibration absorbing pads. The cab has a sliding door on the left side, framed sliding window on the right side, hinged tinted all glass skylight

and removable front windshield to provide optimized visibility of the load open or closed. Acoustical foam padding insulates against sound and weather. Hot air defroster keeps windshield clear. The deluxe six-way adjustable operator's seat is equipped with a torsion bar suspension and includes head and arm rests.

CONTROLS

All control levers and pedals are positioned for efficient operation. Hand operated control levers include swing, boom telescope, boom hoist, winch(s), vernier adjustable hand throttle, and two position house lock. Switches include ignition, engine stop, two-speed winch(s), lights, horn, windshield wipers, defroster, outriggers, etc. Horn and additional winch momentary shift switches are switch mounted in the levers. Foot control pedals include swing brake, boom raise, boom lower, and throttle.

INSTRUMENTATION AND ACCESSORIES

In-cab gauges include bubble level, engine oil pressure, fuel, engine temperature, voltmeter. Indicators include high coolant temperature/low engine oil pressure audio/visual warning, low coolant level audio/visual warning, and Rated Load Indicator. Accessories include fire extinguisher, windshield washer/wiper, skylight wiper, L.H. rear view mirror, dash and dome lights, and seat belt. Circuit breakers protect electrical circuits.

HYDRAULIC CONTROL VALVES

Valves are mounted on the rear of the upperstructure and are easily accessible. Valves are mechanically operated and include one pressure compensated two spool valve for boom elevation and telescope, one pressure compensated two spool valve for main and auxiliary winch, and one single spool valve for swing. High pressure regeneration feature provides 2-speed boom extension. Quick disconnects are provided for ease of installation of pressure check gauges.

OPTIONAL EQUIPMENT

Auxiliary Winch • 360° House Lock • LP Heater/Defroster • Hydraulically Powered Air Conditioner • Diesel Heater/Defroster • Tachometer • Work Lights • Heavy Counterweight Package w/Hydraulic Removal System

STANDARD CARRIER EQUIPMENT

CARRIER CHASSIS

Chassis is Terex designed and built with an 8 x 4 drive. Triple box construction frame with internal diaphragms is fabricated from high strength alloy steel and provides superior frame rigidity. Full aluminum decking improves access and reduces weight. Multiple lockable storage compartments and ground level outrigger controls are built into decking. Aluminum engine housing with sliding cover optimizes engine access while reducing weight and improving corrosion resistance. Mud flaps.

AXLES AND SUSPENSION

Rear Axles - 42,000 lb. (19,051 kg) capacity tandem axles with heat treated housings have inter-axle differential with lockout. Axles are mounted on equalizer beams to distribute weight evenly.
Front Axles - 42,000 lb. (19,051 kg) capacity tubular beam type axles are mounted on standard air suspension system over equalizer beams with shock absorbers.

TIRES

Front: Four 425/65R22.5-18 P.R. All-position type tubeless.
Rear: Eight 11R22.5-14P.R. deep tread drive axle type tubeless

BRAKES

Full air brakes on all wheels with split circuit system
Front brakes: 16.5 x 6 in. (419 x 152 mm)
Rear brakes: 16.5 x 7 in. (419 x 178 mm)
All brakes are air operated "S" cam type with automatic slack adjusters.

Lining areas are 768 in² (4954 cm²) front and 920 in² (5935 cm²) rear. Air compressor has standard air dryer. Rear tandem axles have spring-set,

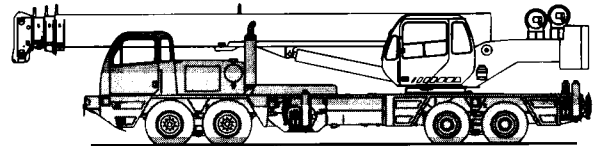

air-released parking or emergency brake chambers. Parking brake is applied with valve mounted on dash panel. Emergency brakes apply automatically when air pressure drops below 60 psi (4.2 kg/cm²).

STEERING

Mechanism includes rack and pinion with integral hydraulic power.

To ϕ of tires
Turning radius: 33'-4" (10.16 m)

TRANSMISSION

Standard: Fuller 10 speed manual transmission (Series 50 engine only).
Optional: CEEMAT automatic transmission has 9 speeds forward and 2 reverse, with neutral safety start. Provides wide ratio coverage with "hands free" shifting. A lock up torque converter further improves performance (Series 60 engine only).

MULTI-POSITION & DOWN OUTRIGGERS

Fully independent hydraulic outriggers may be utilized fully extended to 21 ft. (6.40 m), in their 1/2 extended position, or fully retracted. Removable aluminum outrigger pads are 452 in² (2919 cm²) and stow on the carrier frame. Complete controls and sight leveling bubble are located in the operator's cab. Additional ground level controls are incorporated into the aluminum decking. Includes 5th, front outrigger which incorporates a self stowing permanently attached float.

STANDARD CARRIER EQUIPMENT (continued)

CARRIER CAB

One-man aluminum cab is mounted on vibration absorbing pads and has optimum visibility, safety glass, acoustical foam padding inside cab for insulating against sound and weather, hot air defroster, six-way adjustable torsion bar suspension seat with seat belt and lockable door with roll down window.

CONTROLS

Included are transmission shift, inter-axled differential lock, cruise control, parking brake, two-speed windshield wiper/washer, heater and defroster, lights, headlight dimmer, dome light, and ignition switch.

INSTRUMENTS

Included are speedometer, hour meter, tachometer, voltmeter, fuel gauge, engine oil pressure gauge, water temperature gauge, dual air pressure gauges. Warning lights include low coolant level, parking brakes on, low air, pumps engaged, and high beam lights.

ACCESSORIES

Included are fire extinguisher, right hand and left hand rear view mirrors, electric horn, access steps and grab handles (located at four separate locations around the crane), back-up alarm, two position boom rack, front and rear towing loops.

LIGHTS

Light package includes headlights with foot operated dimmer switch, clearance lights, tail lights, directional signal lights, four-way hazard flasher lights, back-up lights with audible alarm.

OPTIONAL EQUIPMENT

Spare Tire with Wheel • Air Suspension for Rear Tandem • Aluminum Wheels • Immersion Heater(s) • Pintle Hook • Cold Weather Kit • Series 60 Detroit Diesel Engine w/CEEMAT Transmission and Jacobs Brake • Air Suspension for Drivers Seat • Air Conditioner • Ground Level Outrigger Controls

HYDRAULIC SYSTEM

HYDRAULIC PUMPS

Triple pump driven from engine flywheel housing PTO with air shifted mechanical pump disconnect at 1.3 times engine speed. A separate steering pump is driven directly from the engine. Combined system capacity is 115 gpm (435 lpm). Hydraulic oil cooler is standard.

Main and Auxiliary Winch Pump

59.5 gpm (225.2 lpm) @ 3,500 psi (246.1 kg/cm²)

Boom Hoist and Telescope Pump

43.1 gpm (163.1 lpm) @ 3,500 psi (246.1 kg/cm²)

Outrigger and Swing Pump

21.2 gpm (80.2 lpm) @ 2,500 psi (175 kg/cm²)

Power Steering Pump

8 gpm (30.3 lpm) @ 1500 psi (105.5 kg/cm²)

FILTRATION

Full flow oil filtration system with bypass protection includes a removable 60 mesh (250 micron) suction screen-type filter and 5 micron replaceable return line filter.

HYDRAULIC RESERVOIR

All welded construction with internal baffles and diffuser. Provides easy access to filters and is equipped with an external sight level gauge. The hydraulic tank is pressurized to aid in keeping out contaminants and in reducing potential pump cavitation. Capacity is 117 gal (443 liters).

MAIN WINCH SPECIFICATIONS

Hydraulic winch with bent axis piston motor and planetary reduction gearing provides 2-speed operation with equal speeds for power up and down. Winch is equipped with an integral automatic brake, grooved drum, tapered flanges, standard cable roller on drum, and electronic drum rotation indicator.

PERFORMANCE	LO-RANGE	HI-RANGE
Max. line speed (no load)		
First layer	184 fpm (56.1 m/min)	369 fpm (112.5 m/min)
Fifth layer	266 fpm (81.1 m/min)	533 fpm (162.5 m/min)
Max. line pull-first layer	15,639 lbs (7093 kg)	7,298 lbs (3310 kg)
Max. line pull-fifth layer	10,827 lbs (4911 kg)	5,052 lbs (2291 kg)
Permissible line pull	9,000 lbs (4082 kg)	

DRUM DIMENSIONS	DRUM CAPACITY
10.62 in (270 mm) drum diameter	Max. Storage: 939 ft (286.2 m)
22.42 in (570 mm) length	7th layer not a working layer
20.0 in (508 mm) flange dia.	Max. Useable: 772 ft (235.3 m)*
Cable: 5/8 in. x 500 ft (16 mm x 152.4 m)	
Cable type: 5/8 in. (16 mm) 6x19 IWRC IPS right regular lay, preformed	* Based on min. flange height above top layer to comply with ANSI B30.5
Min. breaking strength 17.9 tons (16.2 mt).	

OPTIONAL AUXILIARY WINCH

Hydraulic 2-speed winch with bent axis piston motor, equal speed power up and down, planetary reduction with integral automatic brake, grooved drum with tapered flanges, drum roller, and rotation indicator.

PERFORMANCE

Max. line speed (no load)	
Fifth layer	533 fpm (162.5 m/min)
Max. line pull	
First layer	15,639 lbs. (7093 kg)

DRUM DIMENSIONS AND CAPACITY

(Same as main winch)

OPTIONAL HOIST LINE

MAIN WINCH AND OPTIONAL AUXILIARY WINCH

5/8 in. (16mm) rotation resistant compacted strand 18 x 19 or 19 x 19. Min. breaking strength 22.6 tons (20.6 mt).

ENGINE SPECIFICATIONS

Make and Model	Detroit Diesel	
	Series 50	Series 60
Type	4 cylinder	6 Cylinder
Bore and Stroke	5.12 x 6.30 in. (130 x 160 mm)	5.12 x 6.30 in. (130 x 160 mm)
Displacement	519 cu. in. (8.5 L)	778 cu. in. (12.7 L)
Max. Gross Horsepower	350 hp (261 kw) @ 2100 rpm	420 hp (313 kw) @ 1800 rpm
Max. Gross Torque@rpm	1150 lbs•ft. (1559N•m)@1200 rpm	1450 lb•ft. (1966 N•m)@2100 rpm
Max. Net Horsepower	316 hp (236 kw) @1800 rpm	392 hp (292 kw) @ 1600 rpm
Aspiration	Turbocharged & Aftercooled	Turbocharged & Aftercooled
Electrical System	12 volt	12 volt
Alternator	130 amp	130 amp
Battery @0°F	(3) 12V-2400 C.C.A.	(3) 12V-2400 C.C.A.
Fuel Capacity	100 gal (379 l)	100 gal (379 l)
(Includes standard engine controlled ether starting aid)		

SPEED AND GRADEABILITY

ENGINE TRANSMISSION	SPEED RANGE	GRADEABILITY
50 Series Manual	65 mph (105 km/h)	63%
60 Series CEEMAT	65 mph (105 km/h)	100+%

Performance data is based on a gross vehicle weight of 75,000 lbs. (34 014 kg). Performance may vary due to engine performance, weight, tire size, etc. Gradeability data is theoretical and is limited by tire slip, stability, oil pan angle, etc.

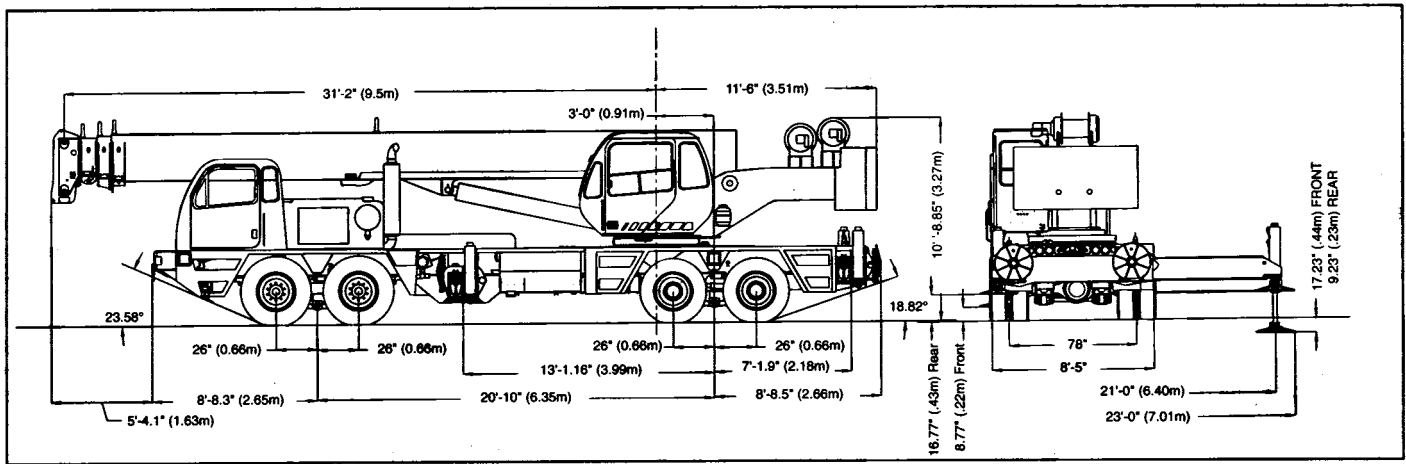

WEIGHTS & AXLE LOADS	GROSS WEIGHT LBS.	UPPER IN TRAVEL POSITION		GROSS WEIGHT KG.	UPPER IN TRAVEL POSITION	
		FRONT	REAR		FRONT	REAR
Basic Crane with 50 Series Engine, 110' (33.52 m) Boom, 5,000 lb (2268 kg) Cwt, 1/4 tank of fuel, 425/65Rx22.5 18 PR Front & 11R22.5 14 PR Rear Tires with Disc Wheels, and 200 lb. Operator in cab.	71,067	30,577	40,490	32 235	13 869	18 366
Add Options:						
32' (9.68m) Swing-on Jib	+ 1,368	+ 1,283	+ 85	+ 620	+ 582	+ 38
32'-57' (9.68 - 17.37m) Swing-on Jib	+ 2,370	+ 1,885	+ 485	+ 1075	+ 855	+ 220
Auxiliary Boom Head	+ 100	+ 168	- 68	+ 45	+ 76	- 31
3,000 lb (1361 kg) Counterweight on Superstructure	+ 3,000	- 1,074	+ 4,074	+ 1361	- 487	+ 1848
6,000 lb (2722 kg) Counterweight on Superstructure	+ 6,000	- 2,148	+ 8,148	+ 2722	- 964	+ 3696
Full Tank of Fuel	+ 545	+ 244	+ 301	+ 247	+ 111	+ 136
Auxiliary Winch W/Drum Roller & Wire Rope	+ 175	+ 13	+ 162	+ 79	+ 6	+ 73
Heater/Defroster (Upper)	+ 60	- 5	+ 65	+ 27	- 2	+ 25
Work Lights	+ 35	+ 8	+ 27	+ 16	+ 4	+ 12
Pintle Hook (Rear)	+ 50	- 20	+ 70	+ 23	- 9	+ 31
Electric Remote Control	+ 200	+ 100	+ 100	+ 91	+ 45	+ 45
50 ton (45.3 mt) Quick Reeving Hook Block (On Bumper - 6 Sheave)	+ 913	+ 1,497	- 584	+ 414	+ 679	- 265
50 ton (45.3 mt) Quick Reeving Hook Block (On Bumper - 5 Sheave)	+ 888	+ 1,329	- 441	+ 403	+ 603	- 200
40 ton (36.3 mt) Quick Reeving Hook Block (On Bumper - 4 Sheave)	+ 690	+ 1,033	- 343	+ 313	+ 469	- 156
30 ton (27.2 mt) Quick Reeving Hook Block (On Bumper - 3 Sheave)	+ 670	+ 1,003	- 333	+ 304	+ 455	- 151
25 ton (22.7 mt) Quick Reeving Hook Block (On Bumper - 2 Sheave)	+ 682	+ 1,021	- 339	+ 309	+ 463	- 154
7 ton (6.3 mt) Hook and Ball (At boom rack)	+ 240	+ 152	+ 88	+ 109	+ 69	+ 40
Substitute:	+ 773	+ 728	+ 45	+ 351	+ 330	+ 21
Detroit Diesel 60 Series Engine - 420 hp (313 kw) W/CEEMAT Transmission						
Spin Resistant Wire Rope (either winch)	+ 32	- 8	+ 40	+ 14	- 4	+ 18
360° Mechanical House Lock	+ 85	0	+ 85	+ 39	0	+ 39
Aluminum Disc Wheels (Std Tires)	- 500	- 268	- 232	- 227	- 122	- 105

NOTE: Weights are for factory supplied equipment and subject to 2% variation due to manufacturing tolerances.

WE RESERVE THE RIGHT TO AMEND THESE SPECIFICATIONS AT ANY TIME WITHOUT NOTICE. THE ONLY WARRANTY APPLICABLE IS OUR STANDARD WRITTEN WARRANTY APPLICABLE TO THE PARTICULAR PRODUCT AND SALE. WE MAKE NO OTHER WARRANTY, EXPRESSED OR IMPLIED.

<http://www.terexlift.com>

TEREX CRANES
Waverly, Iowa

106 12th Street S.E. • Waverly, IA 50677-9466 USA
(319) 352-3920 • FAX: (319) 352-5727

TEREX T 550

truck crane
50 ton capacity

range diagram & lifting capacities

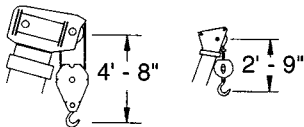

DIMENSIONS ARE FOR LARGEST FACTORY FURNISHED HOOK BLOCK AND HOOK & BALL, WITH ANTI-TWO BLOCK ACTIVATED

Range Diagram
(35' - 110' boom)

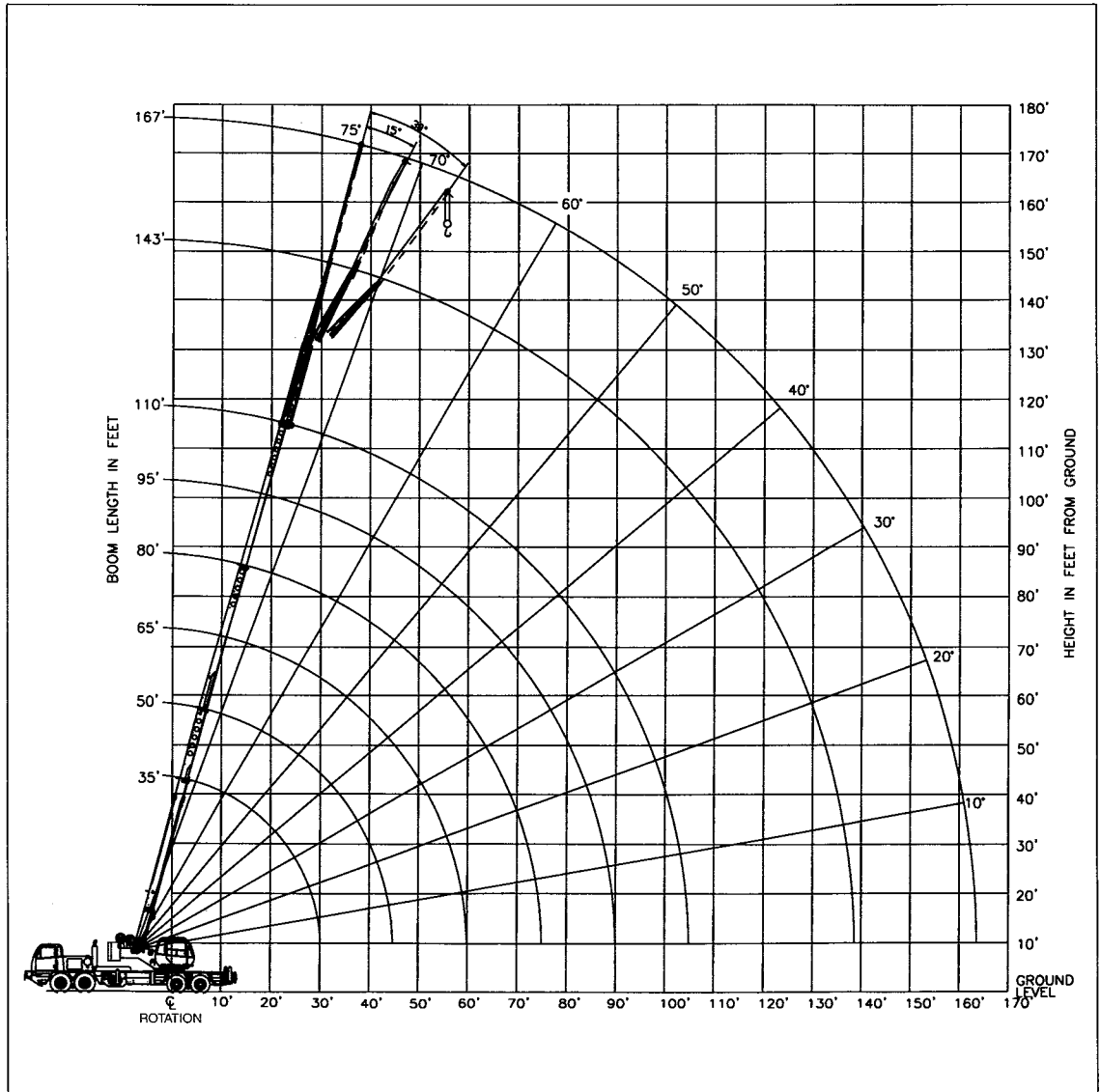

CRANE WORKING CONDITIONS

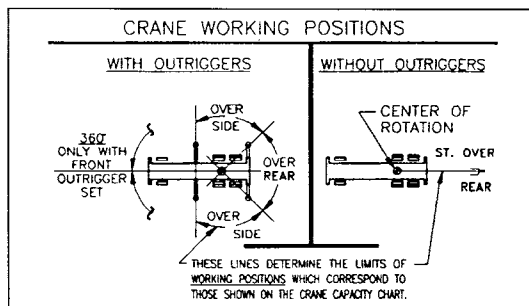

REDUCTION IN MAIN BOOM CAPACITY

All Jibs in Stowed Position	0 Lbs.
Aux. Boom in Head Sheave	100 Lbs.

HOOK BLOCK WEIGHTS

Hook & Ball	239 Lbs.
40T Hook Block (4 Sheave)	690 Lbs.
50T Hook Block (5 Sheave)	888 Lbs.
50T Hook Block (6 Sheave)	913 Lbs.

Lifting Capacities – Pounds (35' – 110' boom)

MODEL T 550

COUNTERWEIGHT:
UPPER:
W/AUX. WINCH 9900 LBS.
W/O AUX. WINCH 11000 LBS.

BOOM LENGTH 35-110 FT.
STABILITY PERCENTAGE:
ON OUTRIGGERS 85%
ON TIRES 75%
PCSA CLASS 12-196

CAUTION: Do not use this specification sheet as a load rating chart. The format of data is not consistent with the machine chart and may be subject to change.

ON OUTRIGGERS - FULLY EXTENDED AND WITH 11000 LB. COUNTERWEIGHT

LOAD RADIUS (FT)	BOOM LENGTH 35 FT			BOOM LENGTH 50 FT			BOOM LENGTH 65 FT			LOAD RADIUS (FT)
	LOADED BOOM ANGLE (DEG)	OVER REAR (LB)	360° (LB)	LOADED BOOM ANGLE (DEG)	OVER REAR (LB)	360° (LB)	LOADED BOOM ANGLE (DEG)	OVER REAR (LB)	360° (LB)	
10	66.7	100,000*	100,000*	73.9	60,100*	60,100*				10
12	63.1	100,000*	100,000*	71.5	60,100*	60,100*				12
15	57.5	83,400*	83,400*	67.9	60,100*	60,100*	73.2	58,800*	58,800*	15
20	47.1	60,200*	60,200*	61.5	60,100*	60,100*	68.5	52,200*	52,200*	20
25	34.5	46,100*	46,100*	54.8	47,500*	47,500*	63.7	46,900*	46,900*	25
30	14.8	36,600*	32,000	47.4	38,100*	33,900	58.6	38,700*	34,400	30
35	**			39.0	31,300*	25,300	53.3	32,000*	25,900	35
40				28.8	26,100	19,600	47.6	26,800	20,300	40
45				12.4	21,000	15,400	41.3	21,900	16,300	45
50					**		34.1	18,200	13,200	50
55							25.2	15,300	10,800	55
60							10.9	13,000	8,800	60
65										65
70										70
75										75
80										80
85										85
90										90
95										95

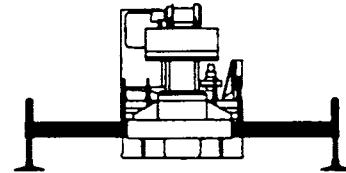

**USE THESE CHARTS ONLY
WHEN ALL OUTRIGGERS
ARE FULLY EXTENDED**

ON OUTRIGGERS - FULLY EXTENDED AND WITH 11000 LB. COUNTERWEIGHT

LOAD RADIUS (FT)	BOOM LENGTH 80 FT			BOOM LENGTH 95 FT			BOOM LENGTH 110 FT			LOAD RADIUS (FT)
	LOADED BOOM ANGLE (DEG)	OVER REAR (LB)	360° (LB)	LOADED BOOM ANGLE (DEG)	OVER REAR (LB)	360° (LB)	LOADED BOOM ANGLE (DEG)	OVER REAR (LB)	360° (LB)	
10										10
12										12
15										15
20	72.7	38,700*	38,700*							20
25	68.9	33,600*	33,600*	72.3	29,300*	29,300*				25
30	65.0	29,600*	29,600*	69.1	25,900*	25,900*	72.1	22,900*	22,900*	30
35	61.0	26,500*	26,200	65.9	23,000*	23,000*	69.3	20,500*	20,500*	35
40	56.8	23,900*	20,600	62.5	20,800*	20,800*	66.5	18,400*	18,400*	40
45	52.4	21,800*	16,600	59.1	18,900*	16,800	63.6	16,500*	16,500*	45
50	47.7	18,600	13,600	55.5	17,300*	13,800	60.7	14,900*	13,900	50
55	42.7	15,800	11,300	51.7	15,900*	11,500	57.7	13,500*	11,600	55
60	37.1	13,500	9,400	47.8	13,700	9,600	54.5	12,300*	9,700	60
65	30.6	11,600	7,800	43.6	11,900	8,100	51.3	11,200*	8,200	65
70	22.6	10,000	6,500	39.0	10,300	6,800	47.8	10,300*	6,900	70
75	9.8	8,600	5,300	33.9	9,000	5,700	44.2	9,200	5,900	75
80	**			28.1	7,900	4,700	40.4	8,100	5,000	80
85				20.8	6,800	3,900	36.1	7,100	4,100	85
90				9.0	5,900	3,100	31.5	6,200	3,400	90
95				**			26.0	5,400	2,800	95
100							19.3	4,700	2,200	100
105							8.4	4,100	1,700	105

** MAXIMUM CAPACITY AT 0 DEGREE BOOM ANGLE

BOOM LENGTH 35 FT			BOOM LENGTH 50 FT			BOOM LENGTH 65 FT			BOOM LENGTH 80 FT			BOOM LENGTH 95 FT			BOOM LENGTH 110 FT		
BOOM LOAD RADIUS (FT)	OVER REAR (LB)	360° (LB)	BOOM LOAD RADIUS (FT)	OVER REAR (LB)	360° (LB)	BOOM LOAD RADIUS (FT)	OVER REAR (LB)	360° (LB)	BOOM LOAD RADIUS (FT)	OVER REAR (LB)	360° (LB)	BOOM LOAD RADIUS (FT)	OVER REAR (LB)	360° (LB)	BOOM LOAD RADIUS (FT)	OVER REAR (LB)	360° (LB)
31.2	21,000*	21,000*	46.2	12,800*	12,800*	61.2	8,400*	8,300	76.2	5,600*	5,000	91.2	3,700*	2,900	106.17	2,400*	1,500

Lifting Capacities – Pounds (35' – 110' boom)

MODEL T 550

COUNTERWEIGHT:
UPPER:
W/AUX. WINCH 9900 LBS.
W/O AUX. WINCH 11000
LBS.

BOOM LENGTH 35-110 FT.
STABILITY PERCENTAGE
ON OUTRIGGERS 85%
ON TIRES 75%
PCSA CLASS 12-196

CAUTION: Do not use this specification sheet as a load rating chart. The format of data is not consistent with the machine chart and may be subject to change.

ON OUTRIGGERS - MID POSITION AND WITH 11000 LB. COUNTERWEIGHT

LOAD RADIUS (FT)	BOOM LENGTH 35 FT		BOOM LENGTH 50 FT		BOOM LENGTH 65 FT		BOOM LENGTH 80 FT		BOOM LENGTH 95 FT		BOOM LENGTH 110 FT		LOAD RADIUS (FT)
	LOADED BOOM ANGLE (DEG)	360° (LB)	LOADED BOOM ANGLE (DEG)	360° (LB)	LOADED BOOM ANGLE (DEG)	360° (LB)	LOADED BOOM ANGLE (DEG)	360° (LB)	LOADED BOOM ANGLE (DEG)	360° (LB)	LOADED BOOM ANGLE (DEG)	360° (LB)	
10	66.7	100,000*	73.9	60,100*									10
12	63.1	92,500*	71.5	60,100*									12
15	57.5	61,700	67.9	60,100*	73.2	58,800*							15
20	47.1	34,200	61.5	35,500	68.5	36,100	72.7	36,500					20
25	34.5	21,900	54.8	23,400	63.7	23,900	68.9	24,300	72.3	24,500			25
30	14.8	14,900	47.4	16,500	58.6	17,100	65.0	17,400	69.1	17,600	72.1	17,700	30
35	**		39.0	12,000	53.3	12,700	61.0	13,000	65.9	13,200	69.3	13,300	35
40			28.8	8,900	47.6	9,600	56.8	10,000	62.5	10,100	66.5	10,300	40
45			12.4	6,500	41.3	7,300	52.4	7,700	59.1	7,900	63.6	8,000	45
50			**		34.1	5,500	47.7	5,900	55.5	6,200	60.7	6,300	50
55					25.2	4,100	42.7	4,500	51.7	4,800	57.7	4,900	55
60					10.9	2,800	37.1	3,400	47.8	3,600	54.5	3,800	60
65					**		30.6	2,400	43.6	2,700	51.3	2,900	65
70							22.6	1,600	39.0	1,900	47.8	2,100	70
75									33.9	1,200	44.2	1,400	75

** MAXIMUM CAPACITY AT 0 DEGREE BOOM ANGLE

BOOM LENGTH 35 FT		BOOM LENGTH 50 FT		BOOM LENGTH 65 FT		BOOM LENGTH 80 FT		BOOM LENGTH 95 FT		BOOM LENGTH 110 FT	
LOAD RADIUS (FT)	360° (LB)	LOAD RADIUS (FT)	360° (LB)	LOAD RADIUS (FT)	360° (LB)	LOAD RADIUS (FT)	360° (LB)	LOAD RADIUS (FT)	360° (LB)	LOAD RADIUS (FT)	360° (LB)
31.2	13,400	46.2	5,900	61.2	2,500						

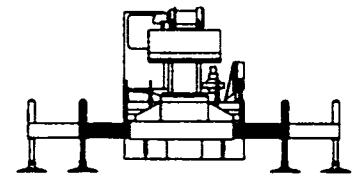

USE THESE CHARTS ONLY WHEN ALL OUTRIGGERS ARE PINNED IN MID POSITION

ON OUTRIGGERS - RETRACTED AND WITH 11000 LB. COUNTERWEIGHT

LOAD RADIUS (FT)	BOOM LENGTH 35 FT		BOOM LENGTH 50 FT		BOOM LENGTH 65 FT		BOOM LENGTH 80 FT		BOOM LENGTH 95 FT		BOOM LENGTH 110 FT		LOAD RADIUS (FT)
	LOADED BOOM ANGLE (DEG)	360° (LB)	LOADED BOOM ANGLE (DEG)	360° (LB)	LOADED BOOM ANGLE (DEG)	360° (LB)	LOADED BOOM ANGLE (DEG)	360° (LB)	LOADED BOOM ANGLE (DEG)	360° (LB)	LOADED BOOM ANGLE (DEG)	360° (LB)	
10	66.7	51,200	73.9	52,400									10
12	63.1	36,600	71.5	37,700									12
15	57.5	24,400	67.9	25,600	73.2	26,100							15
20	47.1	14,000	61.5	15,300	68.5	15,800	72.7	16,100					20
25	34.5	8,400	54.8	9,800	63.7	10,400	68.9	10,700	72.3	10,800			25
30	14.8	4,900	47.4	6,300	58.6	7,000	65.0	7,300	69.1	7,500	72.1	7,600	30
35	**		39.0	4,000	53.3	4,600	61.0	5,000	65.9	5,200	69.3	5,200	35
40			28.8	2,200	47.6	2,900	56.8	3,300	62.5	3,500	66.5	3,600	40
45					41.3	1,600	52.4	2,000	59.1	2,200	63.6	2,400	45
50									55.5	1,200	60.7	1,400	50

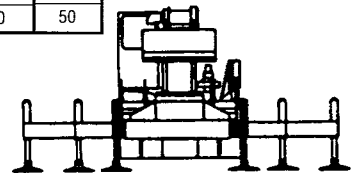

USE THESE CHARTS WHEN ALL OUTRIGGER BEAMS ARE NOT IN EITHER THE MID OR FULLY EXTENDED POSITION

** MAXIMUM CAPACITY AT 0 DEGREE BOOM ANGLE

BOOM LENGTH 35 FT		BOOM LENGTH 50 FT		BOOM LENGTH 65 FT		BOOM LENGTH 80 FT		BOOM LENGTH 95 FT		BOOM LENGTH 110 FT	
LOAD RADIUS (FT)	360° (LB)	LOAD RADIUS (FT)	360° (LB)	LOAD RADIUS (FT)	360° (LB)	LOAD RADIUS (FT)	360° (LB)	LOAD RADIUS (FT)	360° (LB)	LOAD RADIUS (FT)	360° (LB)
31.2	4,000										

Lifting Capacities – Pounds (35' – 110' boom)

MODEL T 550

COUNTERWEIGHT:
UPPER:
W/AUX. WINCH 6900 LBS.
W/O AUX. WINCH 8000 LBS.

BOOM LENGTH 35-110 FT.
STABILITY PERCENTAGE
ON OUTRIGGERS 85%
ON TIRES 75%
PCSA CLASS 12-173

CAUTION: Do not use this specification sheet as a load rating chart. The format of data is not consistent with the machine chart and may be subject to change.

ON OUTRIGGERS - FULLY EXTENDED AND WITH 8000 LB. COUNTERWEIGHT

LOAD RADIUS (FT)	BOOM LENGTH 35 FT			BOOM LENGTH 50 FT			BOOM LENGTH 65 FT			LOAD RADIUS (FT)
	LOADED BOOM ANGLE (DEG)	OVER REAR (LB)	360° (LB)	LOADED BOOM ANGLE (DEG)	OVER REAR (LB)	360° (LB)	LOADED BOOM ANGLE (DEG)	OVER REAR (LB)	360° (LB)	
10	66.7	100,000*	100,000*	73.9	60,100*	60,100*				10
12	63.1	100,000*	100,000*	71.5	60,100*	60,100*				12
15	57.5	81,400*	81,400*	67.9	60,100*	60,100*	73.2	58,800*	58,800*	15
20	47.1	58,700*	58,700*	61.5	59,900*	59,900*	68.5	52,200*	52,200*	20
25	34.5	44,900*	41,900*	54.8	46,200*	43,400*	63.7	46,900*	44,100*	25
30	14.8	35,500*	28,500*	47.4	37,000*	30,300*	58.6	37,700*	30,900*	30
35	**			39.0	30,400*	22,500*	53.3	31,100*	23,100*	35
40				28.8	24,400*	17,200*	47.6	25,200*	17,900*	40
45				12.4	19,600*	13,300*	41.3	20,500*	14,200*	45
50				**			34.1	17,000*	11,400*	50
55							25.2	14,200*	9,200*	55
60							10.9	11,900*	7,400*	60
65							**			65
70										70
75										75
80										80
85										85
90										90
95										95
100										100
105										105

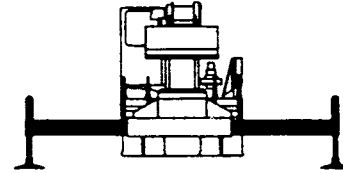

**USE THESE CHARTS ONLY
WHEN ALL OUTRIGGERS
ARE FULLY EXTENDED**

ON OUTRIGGERS - FULLY EXTENDED AND WITH 8000 LB. COUNTERWEIGHT

LOAD RADIUS (FT)	BOOM LENGTH 80 FT			BOOM LENGTH 95 FT			BOOM LENGTH 110 FT			LOAD RADIUS (FT)
	LOADED BOOM ANGLE (DEG)	OVER REAR (LB)	360° (LB)	LOADED BOOM ANGLE (DEG)	OVER REAR (LB)	360° (LB)	LOADED BOOM ANGLE (DEG)	OVER REAR (LB)	360° (LB)	
10										10
12										12
15										15
20	72.7	38,700*	38,700*							20
25	68.9	33,600*	33,600*	72.3	29,300*	29,300*				25
30	65.0	29,600*	29,600*	69.1	25,900*	25,900*	72.1	22,900*	22,900*	30
35	61.0	26,500*	23,400*	65.9	23,000*	23,000*	69.3	20,500*	20,500*	35
40	56.8	23,900*	18,200*	62.5	20,800*	18,400*	66.5	18,400*	18,400*	40
45	52.4	20,800*	14,600*	59.1	18,900*	14,800*	63.6	16,500*	14,900*	45
50	47.7	17,400*	11,800*	55.5	17,300*	12,000*	60.7	14,900*	12,100*	50
55	42.7	14,600*	9,700*	51.7	14,800*	9,900*	57.7	13,500*	10,000*	55
60	37.1	12,400*	7,900*	47.8	12,700*	8,200*	54.5	12,300*	8,300*	60
65	30.6	10,600*	6,500*	43.6	10,900*	6,800*	51.3	11,000*	6,900*	65
70	22.6	9,100*	5,300*	39.0	9,400*	5,600*	47.8	9,600*	5,700*	70
75	9.8	7,800*	4,200*	33.9	8,100*	4,600*	44.2	8,300*	4,800*	75
80	**			28.1	7,000*	3,700*	40.4	7,200*	3,900*	80
85				20.8	6,100*	2,900*	36.1	6,300*	3,200*	85
90				9.0	5,200*	2,200*	31.5	5,500*	2,500*	90
95				**			26.0	4,700*	1,900*	95
100							19.3	4,000*	1,400*	100
105							8.4	3,400*	900*	105

** MAXIMUM CAPACITY AT 0 DEGREE BOOM ANGLE

BOOM LENGTH 35 FT			BOOM LENGTH 50 FT			BOOM LENGTH 65 FT			BOOM LENGTH 80 FT			BOOM LENGTH 95 FT			BOOM LENGTH 110 FT		
BOOM LOAD RADIUS (FT)	OVER REAR (LB)	360° (LB)	BOOM LOAD RADIUS (FT)	OVER REAR (LB)	360° (LB)	BOOM LOAD RADIUS (FT)	OVER REAR (LB)	360° (LB)	BOOM LOAD RADIUS (FT)	OVER REAR (LB)	360° (LB)	BOOM LOAD RADIUS (FT)	OVER REAR (LB)	360° (LB)	BOOM LOAD RADIUS (FT)	OVER REAR (LB)	360° (LB)
31.2	21,900*	21,000*	46.2	12,800*	12,500*	61.2	8,400*	6,900*	76.2	5,600*	3,900*	91.2	3,700*	2,000*	106.17	2,400*	700*

Lifting Capacities – Pounds (35'– 110' boom)

MODEL T 550

COUNTERWEIGHT:
UPPER:
W/AUX. WINCH 3900 LBS.
W/O AUX. WINCH 5000 LBS.

BOOM LENGTH 35-110 FT.
STABILITY PERCENTAGE
ON OUTRIGGERS 85%
ON TIRES 75%
PCSA CLASS 12-196



CAUTION: Do not use this specification sheet as a load rating chart. The format of data is not consistent with the machine chart and may be subject to change.

ON OUTRIGGERS - FULLY EXTENDED AND WITH 5000 LB. COUNTERWEIGHT

LOAD RADIUS (FT)	BOOM LENGTH 35 FT			BOOM LENGTH 50 FT			BOOM LENGTH 65 FT			LOAD RADIUS (FT)
	LOADED BOOM ANGLE (DEG)	OVER REAR (LB)	360° (LB)	LOADED BOOM ANGLE (DEG)	OVER REAR (LB)	360° (LB)	LOADED BOOM ANGLE (DEG)	OVER REAR (LB)	360° (LB)	
10	66.7	100,000*	100,000*	73.9	60,100*	60,100*				10
12	63.1	100,000*	100,000*	71.5	60,100*	60,100*				12
15	57.5	79,300*	79,300*	67.9	60,100*	60,100*	73.2	58,800*	58,800*	15
20	47.1	57,000*	57,000*	61.5	58,400*	58,400*	68.5	52,200*	52,200*	20
25	34.5	43,600*	37,600	54.8	44,900*	40,000	63.7	45,600*	39,700	25
30	14.8	34,400*	25,300	47.4	35,900*	27,100	58.6	36,600*	27,700	30
35	**			39.0	29,100	20,000	53.3	29,700	20,600	35
40				28.8	22,700	15,200	47.6	23,500	15,900	40
45				12.4	18,100	11,600	41.3	19,100	12,500	45
50				**			34.1	15,700	10,000	50
55							25.2	13,000	7,900	55
60							10.9	10,800	6,200	60
65							**			65
70										70
75										75
80										80
85										85
90										90
95										95
100										100
105										105

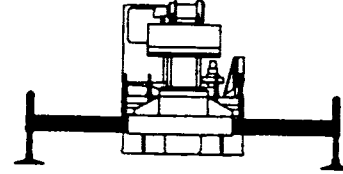

**USE THESE CHARTS ONLY
WHEN ALL OUTRIGGERS
ARE FULLY EXTENDED**

ON OUTRIGGERS - FULLY EXTENDED AND WITH 5000 LB. COUNTERWEIGHT

LOAD RADIUS (FT)	BOOM LENGTH 80 FT			BOOM LENGTH 95 FT			BOOM LENGTH 110 FT			LOAD RADIUS (FT)
	LOADED BOOM ANGLE (DEG)	OVER REAR (LB)	360° (LB)	LOADED BOOM ANGLE (DEG)	OVER REAR (LB)	360° (LB)	LOADED BOOM ANGLE (DEG)	OVER REAR (LB)	360° (LB)	
10										10
12										12
15										15
20	72.7	38,700*	38,700*							20
25	68.9	33,600*	33,600*	72.3	29,300*	29,300*				25
30	65.0	30,000*	28,100	69.1	25,900*	25,900*	72.1	22,900*	22,900*	30
35	61.0	26,500*	20,900	65.9	23,000*	21,200	69.3	20,500*	20,500*	35
40	56.8	23,800	16,200	62.5	20,800*	16,400	66.5	18,400*	16,600	40
45	52.4	19,400	12,900	59.1	18,900*	13,100	63.6	16,500*	13,200	45
50	47.7	16,100	10,400	55.5	16,300	10,600	60.7	14,900*	10,700	50
55	42.7	13,500	8,400	51.7	13,700	8,600	57.7	13,500*	8,700	55
60	37.1	11,400	6,800	47.8	11,600	7,000	54.5	11,800	7,200	60
65	30.6	9,600	5,500	43.6	9,900	5,800	51.3	10,100	5,900	65
70	22.6	8,200	4,400	39.0	8,500	4,700	47.8	8,700	4,800	70
75	9.8	6,900	3,400	33.9	7,300	3,800	44.2	7,500	3,900	75
80	**			28.1	6,200	3,000	40.4	6,400	3,200	80
85				20.8	5,300	2,200	36.1	5,500	2,500	85
90				9.0	4,500	1,600	31.5	4,700	1,900	90
95				**			26.0	4,000	1,300	95
100							19.3	3,400	800	100
105							8.4	2,800		105

** MAXIMUM CAPACITY AT 0 DEGREE BOOM ANGLE

BOOM LENGTH 35 FT			BOOM LENGTH 50 FT			BOOM LENGTH 65 FT			BOOM LENGTH 80 FT			BOOM LENGTH 95 FT			BOOM LENGTH 110 FT		
BOOM LOAD RADIUS (FT)	OVER REAR (LB)	360° (LB)	BOOM LOAD RADIUS (FT)	OVER REAR (LB)	360° (LB)	BOOM LOAD RADIUS (FT)	OVER REAR (LB)	360° (LB)	BOOM LOAD RADIUS (FT)	OVER REAR (LB)	360° (LB)	BOOM LOAD RADIUS (FT)	OVER REAR (LB)	360° (LB)	BOOM LOAD RADIUS (FT)	OVER REAR (LB)	360° (LB)
31.2	20,900*	20,900*	46.2	12,700*	10,800	61.2	8,300*	5,800	76.2	5,600*	3,100	91.2	3,700*	1,400	106.17	2,300*	

Lifting Capacities – Pounds (35'– 110' boom)

MODEL T 550

COUNTERWEIGHT:
UPPER:
W/AUX. WINCH 9900 LBS.
W/O AUX. WINCH 11000 LBS.

BOOM LENGTH 35-110 FT.
STABILITY PERCENTAGE
ON OUTRIGGERS 85%
ON TIRES 75%
PCSA CLASS 12-196

CAUTION: Do not use this specification sheet as a load rating chart. The format of data is not consistent with the machine chart and may be subject to change.

SIDE STOW JIB ON FULLY EXTENDED OUTRIGGERS WITH 11000 LB. COUNTERWEIGHT

LOADED BOOM ANGLE (DEG)	33 FT OFFSETTABLE JIB									57 FT OFFSETTABLE JIB									LOADED BOOM ANGLE (DEG)
	0° OFFSET			15° OFFSET			30° OFFSET			0° OFFSET			15° OFFSET			30° OFFSET			
	(REF) LOAD RADIUS (FT)	REAR ONLY (LB)	360° (LB)	(REF) LOAD RADIUS (FT)	REAR ONLY (LB)	360° (LB)	(REF) LOAD RADIUS (FT)	REAR ONLY (LB)	360° (LB)	(REF) LOAD RADIUS (FT)	REAR ONLY (LB)	360° (LB)	(REF) LOAD RADIUS (FT)	REAR ONLY (LB)	360° (LB)	(REF) LOAD RADIUS (FT)	REAR ONLY (LB)	360° (LB)	
75	42	12,600*	12,600*	49	8,500*	8,500*	56	6,800*	6,600*	50	6,600*	6,600*	64	4,600*	4,600*	74	3,400*	3,400*	75
73	47	11,900*	11,900*	54	8,200*	8,200*	69	6,400*	6,400*	56	6,200*	6,200*	69	4,400*	4,400*	79	3,300*	3,300*	73
71	53	11,300*	11,300*	59	7,800*	7,800*	65	6,300*	6,300*	62	5,900*	5,900*	75	4,200*	4,200*	85	3,200*	3,200*	71
68	60	10,400*	9,900*	66	7,400*	7,400*	71	6,000*	6,000*	70	5,600*	5,600*	82	3,900*	3,900*	91	3,100*	3,100*	68
65	67	9,600*	8,300*	72	7,100*	7,100*	77	5,900*	5,900*	78	5,200*	5,200*	90	3,700*	3,700*	97	3,000*	3,000*	65
62	73	8,900*	6,800*	78	6,800*	6,100*	83	5,700*	5,700*	86	4,800*	4,800*	97	3,500*	3,500*	104	2,900*	2,900*	62
59	80	8,300*	5,700*	84	6,500*	5,100*	89	5,500*	4,900*	95	4,500*	4,400*	104	3,400*	3,300*	110	2,800*	2,800*	59
55	87	6,900*	4,500*	91	6,200*	4,200*	96	5,300*	4,000*	105	4,100*	3,500*	112	3,200*	3,200*	117	2,700*	2,700*	55
51	93	5,800*	3,500*	99	5,500*	3,300*	103	5,200*	3,100*	114	3,800*	2,700*	120	3,000*	2,500*	124	2,700*	2,200*	51
47	99	5,000*	2,800*	106	4,700*	2,500*	109	4,700*	2,500*	122	3,500*	2,100*	127	2,900*	1,900*	130	2,600*	1,800*	47
43	106	4,300*	2,100*	112	4,100*	2,000*	114	4,000*	1,900*	129	3,300*	1,500*	134	2,800*	1,400*	136	2,600*	1,300*	43
38	114	3,600*	1,500*	119	3,400*	1,400*	120	3,300*	1,300*	137	2,700*	1,000*	141	2,600*	900*	142	2,600*	900*	38
32	121	2,800*	900*	125	2,700*	700*	127	2,700*	700*	145	2,200*		148	2,100*		149	2,100*		32
25	128	2,200*		131	2,100*					152	1,700*		154	1,600*					25
17	134	1,800*		136	1,700*					159	1,300*		159	1,300*					17
0	140	500*								164	400*								0

Notes For Jib Capacities:

- F. For all boom lengths less than the maximum with a jib erected, the rated loads are determined by boom angle only in the appropriate column.
- G. For boom angles not shown, use the capacity of the next lower boom angle.
- H. Listed radii are for fully extended main boom only.

ON TIRES WITH 11000 LB. COUNTERWEIGHT

MAX RADIUS (FT)	BOOM LENGTH (FT)	ALL		
		STATIONARY	PICK & CARRY	
			CREEP	2.5 MPH
STRAIGHT OVER REAR				
10	35	23,500	23,500	16,100*
12	35	22,400	22,400	14,400*
15	35	20,700	20,700	12,200*
20	50	18,000	16,700	9,200*
25	50	15,200	13,600	6,900*
30	50	11,200	11,000	5,000*
35	50	8,900	8,900	3,700*
40	65	7,400	7,400	2,800*
45	65	6,000	6,000	2,100*
50	65	4,700	4,700	1,500*
55	65	3,800	3,800	
60	80	3,000	3,000	
65	80	2,300	2,300	
70	80	1,800	1,800	

Notes For On Tire Capacities:

- A. For Pick and Carry Operations, boom must be centered over the rear of the machine.
- B. The load should be restrained from swinging.
- C. Creep Speed is crane movement of less than 200 ft. (61 m) in a 30 minute period and not exceeding 1.0 mph (1.6 km/h).
- D. Refer to General Notes for additional information.
- E. Without outriggers, never maneuver the boom beyond listed load radii for applicable tires used to ensure stability.

MAXIMUM PERMISSIBLE HOIST LINE LOAD

LINE PARTS	1	2	3	4	5	6	7	8	9	10	11	12
MAX. LOAD(18x19)	9,080	18,160	27,240	36,320	45,400	54,480	63,560	72,640	81,720	90,800	99,880	108,960
MAX. LOAD(6X19)	10,000	20,000	30,000	40,000	50,000	60,000	70,000	80,000	90,000	100,000	110,000	120,000
BOOM HEAD	2	3-D	2-3	1-4-D	2-3-4	2-3-4-D	1-2-3-4	1-2-3-4-D	1-2-3-4-5	1-2-3-4-5-D	1-2-3-4-5-6-D	1-2-3-4-5-6-D
HOOK BLOCK	D	3	3-D	1-4	2-3-D	2-3-4	2-3-4-D	1-2-3-4	1-2-3-4-D	1-2-3-4-5	1-2-3-4-5	1-2-3-4-5-6
WIRE ROPE: 5/8" ROTATION RESISTANT COMPACTED STRAND, 18X19 OR 19X19 MINIMUM BREAKING STRENGTH – 22.7 TONS 5/8" 6X9 OR 6X37 IWRC IPS PREFORMED RIGHT REGULAR LAY MINIMUM BREAKING STRENGTH – 17.9 TONS												

GENERAL NOTES

GENERAL

1. Rated loads as shown on Lift Charts pertain to this machine as originally manufactured and equipped. Modifications to the machine or use of optional equipment other than that specified can result in a reduction of capacity.
2. Construction equipment can be hazardous if improperly operated or maintained. Operation and maintenance of this machine shall be in compliance with the information in the Operator's, Parts and Safety Manuals supplied with this machine. If these manuals are missing, order replacements from the manufacturer through your distributor.
3. These warnings do not constitute all of the operating conditions for the crane. The operator and job site supervision must read the OPERATORS MANUAL, CIMA SAFETY MANUAL, APPLICABLE OSHA REGULATIONS, AND SOCIETY OF MECHANICAL ENGINEERS (ASME) SAFETY STANDARDS FOR CRANES.
4. This crane and its load ratings are in accordance with POWER CRANE & SHOVEL ASSOCIATION, STANDARD NO. 4, SAE CRANE LOAD STABILITY TEST CODE J765A, SAE METHOD OF TEST FOR CRANE STRUCTURE J1063 AND APPLICABLE SAFETY CODE FOR CRANES, DERRICKS AND HOISTS, ASME/ANSI B30.5.

DEFINITIONS

1. **LOAD RADIUS** – The horizontal distance from the axis of rotation before loading to the center of the vertical hoist line or tackle with a load applied.
2. **LOADED BOOM ANGLE** – It is the angle between the boom base section and the horizontal, after lifting the rated load at the rated radius. The boom angle before loading should be greater to account for deflections. The loaded boom angle combined with boom length give only an approximation of the operating radius.
3. **WORKING AREA** – Areas measured in a circular arc about the centerline of rotation as shown in the diagram.
4. **FREELY SUSPENDED LOAD** – Load hanging free with no direct external force applied except by the hoist rope.
5. **SIDE LOAD** – Horizontal force applied to the lifted load either on the ground or in the air.
6. **NO LOAD STABILITY LIMIT** – The stability limit radius shown on the range diagrams is the radius beyond which it is not permitted to position the boom, when the boom angle is less than the minimum shown on the applicable load chart, because the machine can overturn without any load.
7. **BOOM SIDE OF CRANE** – The side of the crane over which the boom is positioned when in an OVER SIDE working position.

SET-UP

1. Crane load ratings are based on the crane being leveled and standing on a firm, uniform supporting surface.
2. Crane load ratings on outriggers are based on all outrigger beams being fully extended or in the case of partial extension ratings mechanically pinned in the appropriate position, and the tires free of the supporting surface.
3. Crane load ratings on tires depend on appropriate inflation pressure and the tire conditions. Caution must be exercised when increasing air pressures in tires. Consult Operator's Manual for precautions.
4. Use of jibs, lattice-type boom extensions, or fourth section pullouts extended is not permitted for pick and carry operations.
5. Consult appropriate section of the Operator's and Service Manual for more exact description of hoist line reeving.
6. The use of more parts of line than required by the load may result in having insufficient rope to allow the hook block to reach the ground.
7. Properly maintained wire rope is essential for safe crane operation. Consult Operator's Manual for proper maintenance and inspection requirements.

8. When spin-resistant wire rope is used, the allowable rope loading shall be the breaking strength divided by five (5), unless otherwise specified by the wire rope manufacturer.

OPERATION

1. **CRANE LOAD RATINGS MUST NOT BE EXCEEDED. DO NOT ATTEMPT TO TIP THE CRANE TO DETERMINE ALLOWABLE LOADS.**
2. When either radius or boom length, or both, are between listed values, the smaller of the two listed load ratings shall be used.
3. Do not operate at longer radii than those listed on the applicable load rating chart (cross hatched areas shown on range diagrams).
4. The boom angles shown on the Capacity Chart give an approximation of the operating radius for a specified boom length. The boom angle, before loading, should be greater to account for boom deflection. It may be necessary to retract the boom if maximum boom angle is insufficient to maintain rated radius.
5. Power telescoping boom sections must be extended equally.
6. Rated loads include the weight of hook block, slings, and auxiliary lifting devices. Their weights shall be subtracted from the listed rated load to obtain the net load that can be lifted.
When lifting over the jib the weight of any hook block, slings, and auxiliary lifting devices at the boom head must be added to the load.
When jibs are erected but unused add two (2) times the weight of any hook block, slings, and auxiliary lifting devices at the jib head to the load.
7. Rated loads do not exceed 85% on outriggers or 75% on tires, of the tipping load as determined by SAE Crane Stability Test Code J765a. Structural strength ratings in chart are indicated with an asterisk (*).
8. Rated loads are based on freely suspended loads. No attempt shall be made to drag a load horizontally on the ground in any direction.
9. The user shall operate at reduced ratings to allow for adverse job conditions, such as: Soft or uneven ground, out of level conditions, high winds, side loads, pendulum action, jerking or sudden stopping of loads, hazardous conditions, experience of personnel, two machine lifts, traveling with loads, electric wires, etc., (side pull on boom or jib is hazardous). Derating of the cranes lifting capacity is required when wind speed exceeds 20 MPH. The center of the lifted load must never be allowed to move more than 3' feet off the center line of the base boom section due to the effects of wind, inertia, or any combination of the two.
"Use 2 feet off the center line of the base boom for a two section boom, 3 feet for a three section boom, or 4 feet for a four section boom."
10. The maximum load which can be telescoped is not definable, because of variations in loadings and crane maintenance, but it is permissible to attempt retraction and extension if load ratings are not exceeded.
11. Load ratings are dependent upon the crane being maintained according to manufacturer's specifications.
12. It is recommended that load handling devices, including hooks, and hook blocks, be kept away from boom had at all times.
13. **FOR TRUCK ONLY:** 360° capacities apply only to machines equipped with a front outrigger jack and all five (5) outrigger jacks properly set. If the front (5th) outrigger jack is not properly set, the work area is restricted to the over side and over rear areas as shown on the Crane Working Positions diagram. Use the 360° load ratings in the overside work areas.
14. Do not lift with outrigger beams positioned between the fully extended and intermediate (pinned) positions.

WE RESERVE THE RIGHT TO AMEND THESE SPECIFICATIONS AT ANY TIME WITHOUT NOTICE. THE ONLY WARRANTY APPLICABLE IS OUR STANDARD WRITTEN WARRANTY APPLICABLE TO THE PARTICULAR PRODUCT AND SALE. WE MAKE NO OTHER WARRANTY, EXPRESSED OR IMPLIED.



TEREX CRANES

106 12th Street S.E.
Waverly, IA 50677-9466 USA
(319) 352-3920 • FAX: (319) 352-5727
E-mail: waverly@terexlifting.com

www.terexlift.com