

# GROVE®

## RT530E

**product  
guide**



 30 tonnes

 29 m

 7.9 - 13.7 m

 45 m

Rough Terrain Crane • Geländekran • Grue Tout-Terrain  
Grúa Todo Terreno • Autogru Fuoristrada

<b>Specification</b>	<b>3</b>
<b>Technische Daten</b>	<b>4</b>
<b>Caractéristiques techniques</b>	<b>5</b>
<b>Características</b>	<b>6</b>
<b>Caratteristiche</b>	<b>7</b>
<b>Data • Daten • Caractéristiques • Datos • Dati</b>	<b>8</b>
<b>Dimensions • Abmessungen • Enncombrement • Dimensiones • Dimensioni</b>	<b>9</b>
<b>Loadcharts • Traglasten • Capacités de levage • Capacidades • Capacità</b>	
Notes • Hinweise • Notes • Notas • Note	<b>10</b>
Working Range • Arbeitsbereiche • Diagramme de levage • Gama de trabajo • Area di lavoro	<b>11</b>
Telescopic Boom • Teleskopausleger • Flèche principale • Pluma telescópica • Braccio telescopico	<b>12</b>
Swingaway • Klappspitze • Extension treillis • Plumín • Jib	<b>16</b>
Weight Reductions • Gewichte der Lastaufnahmemittel • Réductions de charge • Reducciones de peso • Riduzioni di peso	<b>18</b>
<b>Notes • Hinweise • Notes • Notas • Note</b>	
Symbols • Symbolerklärung • Glossaire des symboles • Glosario de simbolos • Glossario dei simboli	<b>19</b>

## Superstructure

### Boom

8.8 m to 29.0 m four section full power boom.  
Maximum tip height 31.2 m.

### Boom Elevation

1 cylinder with safety valve, boom angle from -3° to 76°.

### Load moment and anti-two block system

Standard "Graphic Display" load moment and anti-two block system with audio-visual warning and control lever lockout. These systems provide electronic display of boom angle, length, radius, tip height, relative load moment, maximum permissible load, load indication and warning of impending two-block condition. The standard Work Area Definition System allows the operator to pre-select and define safe working areas. If the crane approaches the pre-set limits, audio-visual warnings aid the operator in avoiding job-site obstructions.

### Cab

Galvanealed steel, acoustically treated, opening skylight with electric wiper and skylight sunscreen, deluxe seat with armrest-integrated crane controls, engine dependent hot water heater. Ergonomically arranged instrumentation and crane operating controls. Drive/steer controls.

### Slewing

360° continuous rotation, planetary glide swing with foot applied brake. Spring applied hydraulically released parking brake and plunger type, 1 position mechanical house lock.

### Counterweight

3,810 kg removable, plus slab in place of \*auxiliary hoist.

### Hydraulic system

3 main gear pumps combined capacity 381 l/min. Return line filter with by-pass protection. Remote mounted thermostatically controlled oil cooler and system pressure test ports. Tank capacity: 341 l.

### Control system

Stepless control of all crane movements using single axis hydraulic pilot control levers with automatic reset to zero.

### Hoist

Axial piston motor with planetary gear and automatic spring applied multi-disc brake. Grooved drum, hoist drum cable followers and electronic rotation indicator. 6x37 class hoist rope for 3.5:1 F.O.S.

### \* Optional equipment

7.9 m swingaway (offsets 0°, 30°).  
7.9 - 13.7 m telescopic swingaway (offsets 0°, 30°).  
Additional boom nose sheave and 35x7 class hoist rope for 5:1 F.O.S.  
Auxiliary hoist package (includes auxiliary boom nose).  
360° mechanical slew lock operated from cab.  
Air conditioning.  
LMI light bar

## Carrier

### Carrier frame

Special 2-axle carrier, all-welded torsion-resistant box type construction in high strength steel. Integral towing and tie down lugs.

### Outriggers

4 hydraulically telescoping beams with 'inverted' jacks and 419 mm square outrigger pads. Independent horizontal and vertical movement control from the crane operator's cab. Three position setting. Sight level gauge.  
Maximum outrigger pad load: 22,498 kg.

### Engine

Cummins 6BT5.9L, 6 cylinder water cooled, turbocharged diesel. 113 kW (152 bhp) at 2500 rpm. Max. torque: 561 Nm at 1500 rpm. Fuel tank capacity: 220 l. Engine emission: EUROMOT / EPA CARB (non road). Engine block heater

### Transmission

Dana (Clark) powershift T20000 series, 6 forward and 6 reverse speeds.

### Drive/Steer

4 x 4 x 4

### Axles

2 axles driven and steered. Front axle disconnect for 4 x 2 travel.

### Suspension

Front axle rigid mounted to frame. Rear axle pivot mounted. Automatic oscillation lockouts permit oscillation only with boom centred over front.

### Tyres

4 tyres, 20.5 x 25 - 24 PR earthmover type.

### Steering

Front, full hydraulic steering wheel controlled. Separate steering of the rear axle for rear, crab and coordinated steering.

### Brakes

Service brake: hydraulic dual circuit acting on all wheels.  
Parking brake: spring-applied, hydraulically released transmission mounted.

### Electrical system

12 V (Two 12 V maintenance free batteries).

### \* Optional equipment.

CE Mark Conformance.  
4 tyres 16.00 x 25 - 28 PR (vehicle width 2.54 m).  
Cross axle differential locks  
Battery disconnect.  
Rear pintle hook.  
Aluminium decking.

\*Further optional equipment upon request

## Technische Daten

4

### Kranoberwagen

#### Teleskopausleger

8,8 m bis 29,0 m vollhydraulisch teleskopierbarer 4-Stufen-Ausleger.  
Maximale Rollenhöhe 31,2 m.

#### Wippwerk

1 Hubzylinder mit Sicherheitsventil, Auslegerwinkel -3° bis 76°.

#### Lastmomentbegrenzer und Hubendabschaltesystem

Standard "Grafische Darstellung" Lastmomentbegrenzer und Hubendabschaltesystem mit audio-visueller Warneinrichtung und Bedienhebelabschaltung. Diese Systeme bieten eine elektronische Anzeige von Auslegerwinkel, Auslegerlänge, Ausladung, Rollenhöhe, relative Last, maximal zulässige Last, tatsächliche Last sowie eine Hubende-Warneinrichtung. Durch die Arbeitsbereich-begrenzung kann der Bediener sichere Arbeitsbereiche definieren. Fährt der Kran auf die Begrenzung des sicheren Arbeitsbereichs zu, wird der Bediener hörbar und visuell gewarnt. So können Kollisionen auf der Baustelle vorgebeugt werden.

#### Kabine

Verzinkte, schallgedämmte Stahlkabine, aufklappbares Dachfenster mit elektrischem Scheibenwischer und Sonnenschutz, Komfortsitz mit in die Armlehnen integrierten Bedienhebeln, motorabhängige Heisswasserheizung. Ergonomisch angeordnete Bedienelemente und Kranbedienhebel. Fahr- und Lenkbedienung.

#### Drehwerk

360° rundum kontinuierlich schwenkbar, Planetenschwenkwerk mit Fusspedalschwenkbremse. Hydraulisch lösbare Federspeicher-Feststellbremse und mechanische, in 1 Stellung verriegelbare Bolzenverriegelung.

#### Gegengewicht

3810 kg abnehmbares Gegengewicht sowie ein Zusatzgewicht anstelle der \*wahlweisen Hilfswinde.

#### Hydrauliksystem

3 Hauptzahnradpumpen mit einer Gesamtfördermenge von 381 l/Min. Filter mit Vollstrom-Überströmventil im Rücklauf. Abgesetzt montierter, thermostatisch geregelter Ölkühler und Druckkontrollanschlüsse. Tankfassungsvermögen: 341 l.

#### Steuerung

Stufenlose Bedienung aller Kranbewegungen mittels hydraulischer Einachs-Bedienhebel mit automatischer Rückführung in die Nullstellung.

#### Hubwerk

Axielkolbenmotor mit Planetengetriebe und automatischer Federspeicher-Lamellenbremse. Gerillte Seiltrommel, Windenseilführung und elektronische Umdrehungsanzeige. Typ 6x37 Hubseil für 3.5:1 Sicherheitsfaktor.

#### \* Zusatzausüstung

7,9 m Klappspitze (abwinkelbar 0°, 30°).  
7,9 - 13,7 m Teleskopklappspitze (abwinkelbar 0°, 30°).  
Zusätzliche Seilscheibe am Auslegerkopf und Typ 35x7 Hubseil für 5:1 Sicherheitsfaktor.  
Hilfswinde-Paket (einschl. Hilfsrollenkopf).  
Von der Kabine aus bedienbare mechanische 360°-Schwenkwerkverriegelung.  
Klimaanlage.  
LMB (Lastmomentbegrenzer) Leuchtbalkenanzeige.

### Kranunterwagen

#### Rahmen

2-Achsen-Spezial-Unterwagenrahmen, vollverschweißte, verwindungsfeste Kastenprofil-Konstruktion aus hochfestem Stahl. Integrierte Schlepp- und Verstauesen.

#### Abstützung

4 hydraulisch teleskopierbare Abstützträger mit innengeführten Stützzyindern und 419 mm quadratischen Abstütztellern. Unabhängige Bedienung der horizontalen und vertikalen Bewegungen von der Krankabine aus. Teilauslage in 3 Stellungen verholzbar. Nivellierlibelle. Maximale Stütztellerlast: 22,498 Kg.

#### Motor

Cummins 6BT5.9L, wassergekühlter 6-Zylinder-Turbodieselmotor. 113 KW (152 PS) bei 2500 U/Min. Max. Drehmoment: 561 Nm bei 1500 U/Min. Fassungsvermögen Treibstofftank: 220 l. Abgasemission: EUROMOT / EPA / CARB (nicht Strasse). Motorblock-Heizung.

#### Getriebe

Dana (Clark) Powershiftautomatikgetriebe Serie T20000, 6 Vorwärtsgänge und 6 Rückwärtsgänge.

#### Antrieb/Lenkung

4 x 4 x 4

#### Achsen

Zwei Achsen angetrieben und lenkbar. Vorderachse für 4 x 2 Fahrt abschaltbar.

#### Federung

Vorderachse starr am Unterwagenrahmen montiert. Hinterachse als Pendelachse montiert. Die automatische Federungsverriegelung entriegelt die Federung nur dann, wenn der Ausleger nach vorn zeigt.

#### Bereifung

4 Reifen, 20.5 x 25 - 24 PR Radladerreifen.

#### Lenkung

Vorn vollhydraulische Lenkung mittels Lenkrad. Separate Lenkung der Hinterachse für hintere Lenkung, Hundegang oder koordinierte Lenkung.

#### Bremsen

Betriebsbremse: Zweikreis-Hydraulik-Bremssystem, auf alle Räder wirkend. Feststellbremse: Hydraulisch lösbare Federspeicher-Feststellbremse am Getriebe montiert.

#### Elektrische Anlage

12 V (Zwei 12 V wartungsfreie Batterien).

#### \* Zusatzausrüstung

CE Zertifikat.  
4 Reifen, 16.00 x 25 - 28 PR (Fahrzeugbreite 2,54 m).  
Querdifferentialsperren  
Batterietrennung.  
Abschlepphaken.  
Aluminiumdeck.

RT530E

## Superstructure

### Flèche

Flèche quatre éléments de 8,8 m à 29,0 m à télescopage hydraulique. Hauteur max. de tête de flèche 31,2 m.

### Relevage

1 vérin avec clapet anti-retour, angle de flèche de -3° à + 76°.

### Contrôleur d'état de charge et dispositif de fin de course haute

Contrôleur d'état de charge à affichage graphique et dispositif de fin de course haute avec alarme sonore et visuelle et dispositif de coupure des mouvements. Ces dispositifs électroniques affichent les indications d'angle et de longueur de flèche, de portée, de hauteur de tête de flèche, de moment relatif, de charge maximum admissible, de charge levée et d'approche de bloc à bloc. Le dispositif de définition de domaine de travail, monté de série, permet à l'utilisateur de définir des limites de zone de travail. Si la grue approche ces limites, des alarmes sonores et visuelles préviennent l'utilisateur.

### Cabine

Cabine en tôle galvanisée, insonorisée, avec baie de toit ouvrante, essuie glace électrique et rideau pare-soleil, siège capitonné avec commandes de grue montées sur les accoudoirs, chauffage à eau chaude alimenté par le moteur thermique. Disposition ergonomique de l'instrumentation et des commandes de grue. Commandes de conduite pour le déplacement et la direction du porteur.

### Orientation

Orientation continue sur 360° avec réducteur à planétaires « glide swing » et frein au pied. Frein d'immobilisation à serrage par ressorts et desserrage hydraulique. Axe de verrouillage d'orientation sur une position.

### Contrepoids

Contrepoids de 3.810 kg déposable plus plaque amovible en lieu de treuil auxiliaire.

### Circuit hydraulique

3 pompes principales à engrenages ayant un débit total de 381 l/min. Filtration sur circuit retour avec circuit « by-pass ». Refroidisseur d'huile hydraulique à commande thermostatique monté à distance et panneau de prises de pressions centralisées. Capacité du réservoir : 341 l.

### Commandes de grue

Commandes progressives par leviers simple axe et retour au neutre automatique.

### Treuil

Moteur à pistons axiaux avec réducteur à planétaires et frein automatique à serrage par ressorts et desserrage automatique. Treuil rainuré, rouleau presse câble et indicateur électronique de rotation du tambour. Câble de levage classe 6x37 donnant un coefficient de sécurité de 3.5:1

### \* Equipements optionnels

Extension à repliage latéral de 7,9 m (inclinable à 0° et 30°).  
Extension à repliage latéral et télescopique de 7,9 à 13,7 m (inclinable à 0° et 30°).  
Poulie additionnelle et câble de levage classe 35x7 donnant un coefficient de sécurité de 5:1  
Equipement treuil auxiliaire (incluant la tête de flèche auxiliaire).  
Dispositif de verrouillage mécanique sur 360°, commandé depuis la cabine.  
Climatisation.  
Barre de répétition d'affichage de moment C.E.C.

## Porteur

### Châssis porteur

Châssis caissonné, mécanosoudé, spécifique, à 2 essieux, en tôles d'acier à haute limite élastique, avec oreilles de remorquage et d'arrimage intégrées.

### Calage

4 poutres à télescopage hydraulique avec vérins verticaux en position « inversée » et semelles d'appui carrées de 419 mm de côté. Commande indépendante des mouvements de sortie de poutres et de vérins depuis le poste de pilotage. Trois configurations de calage sont autorisées, 0 - 50 et 100%. Niveau à bulle. Charge maximum sur les appuis: 22,498 kg.

### Moteur

Moteur Diesel Cummins 6BT5.9L, 6 cylindres, à refroidissement liquide et dispositifs de suralimentation. 113 kW (152 CV) à 2500 tr/min. Couple max.: 561 Nm à 1500 tr/min. Capacité du réservoir de carburant : 220 l. Emissions de gaz polluants: EUROMOT / EPA CARB (normes chantier). Réchauffage du bloc-moteur

### Boîte de vitesses

Boîte de vitesses Dana (Clark) T20000, 6 rapports de marche avant et 6 rapports de marche arrière.

### Direction/Déplacement

4 x 4 x 4

### Ponts

2 ponts moto-directeurs. Pont avant débrayable pour déplacements sur route.

### Suspension

Pont avant rigide fixé au châssis. Pont arrière articulé. Le dispositif automatique de verrouillage d'articulation libère la suspension lorsque la flèche est centrée sur l'avant.

### Pneumatiques

4 pneumatiques 20.5 x 25 - 24 PR de type chantier.

### Direction

Direction avant hydraulique commandée par volant. Direction indépendante pour les roues arrière donnant les configurations : direction arrière, marche en crabe et direction coordonnée.

### Freins

Frein de service: double circuit hydraulique agissant sur toutes les roues. Frein de stationnement: à serrage par ressorts et desserrage hydraulique agissant sur la transmission.

### Circuit électrique

12 V (Deux batteries 12 V sans entretien).

### \* Equipements optionnels

Conformité CE.  
4 pneus, 16.00 x 25 - 28 PR (largeur du véhicule 2,54 m).  
Blocages de différentiels inter-roues.  
Coupe batteries.  
Crochet de remorquage.  
Platelage en aluminium.

\* Autres équipements optionnels sur demande

## Características

6

### Superestructura

#### **Pluma**

De 8,8 m. hasta 29,0 m. en 4 tramos de telescopaje totalmente hidráulico. Altura máxima en punta 31,2 m.

#### **Elevación de pluma**

Un cilindro con válvula de seguridad. Angulo de pluma desde -3° hasta 76°.

#### **Sistema Indicador del Momento de Carga y de Final de Carrera del Gancho**

La Pantalla Gráfica estandar. Indicador del momento de carga y de final de carrera del gancho con alarma audiovisual y bloqueo automático de las palancas de control. Estos sistemas proporcionan información en la pantalla del ángulo de pluma, longitud, radios, altura, momento de carga relativo, carga máxima permitida, indicador de carga y alarma de final de carrera del gancho. El sistema estandar de Area Definida de Trabajo permite al operador preseleccionar y definir las zonas seguras de trabajo. Si la grúa se acerca a los límites preseleccionados, la alarma audio-visual avisa al operario para evitar obstrucciones en el lugar de trabajo.

#### **Cabina**

De acero galvanizado, tratada acústicamente, ventana superior abatible con limpia-parabrisas eléctrico y persiana parasol en techo, asiento de lujo con controles de operación de la grúa e instrumentación ergonómicamente situadas, calefacción por agua caliente del motor. Controles de traslación/dirección.

#### **Giro**

Continuo a 360°, giro deslizante con planetarios y freno actuado por pedal. Freno de aparcamiento aplicado por muelle con desconexión hidráulica y pistón, bloqueo mecánico en 1 posición.

#### **Contrapeso**

De 3.810 kg. desmontable, más una placa en lugar del \*cabrestante auxiliar.

#### **Sistema hidráulico**

Tres bombas principales de engranaje con una capacidad combinada de 381 litros/minuto. Filtro en la línea de retorno con protección by-pass. Radiador de refrigeración de aceite con control por termostato y sistema de comprobación de presión en el panel. Capacidad del depósito 341 litros.

#### **Sistema de Control**

Controles continuos de todos los movimientos de la grúa, usando palancas de control con retorno automático a cero.

#### **Cabrestante**

Con motor de pistón axial, engranaje planetario y freno automático multidisco aplicado por muelle. Tambor acanalado, ordenador de cable en el tambor e indicador de dirección. Cable del cabrestante con un factor de seguridad de 3.5 a 1.

#### \* Equipos Opcionales

Plumín de 7,9 m. fijo, plegable en un lateral de la pluma (angulable 0° y 30°). Plumín telescópico de 7,9-13,7 m. plegable en un lateral de la pluma (angulable 0° y 30°).

Cabeza adicional tipo nariz con una polea y cable 35x7 con un factor de seguridad de 5 a 1.

Conjunto de cabrestante auxiliar (incluye la cabeza auxiliar tipo nariz).

Bloqueo mecánico de giro en los 360° accionado desde la cabina.

Aire acondicionado.

Tubo de iluminación del Indicador de cargas.

### Chasis

#### **Bastidor**

Chasis especial de dos ejes de construcción soldada tipo cajón resistente a la torsión, en acero de alta resistencia. Gancho de arrastre y orejetas de amarre.

#### **Estabilizadores**

4 vigas telescópicas hidráulicas con cilindros verticales invertidos y placas de apoyo cuadradas de 419 mm. de superficie. Controles independientes para los movimientos horizontales y verticales desde la cabina del operador. Tres posiciones de aplicación. Manómetro indicador de nivel. Carga máxima en cada placa de apoyo 22,498 kg.

#### **Motor**

Diesel Cummins 6BT5.9L, 6 cilindros, refrigerado por agua, turbo-alimentado, 113 Kw (152 bhp) a 2.500 rpm. Par máximo: 561 Nm a 1.500 rpm. Depósito de combustible: 220 litros. Emisión de gases: EUROMOT/EPA/CARB (non-road). Calentamiento del bloque motor.

#### **Transmisión**

Dana (Clark) powershift serie T20000, 6 velocidades adelante y 6 atrás.

#### **Tracción/Dirección**

4 x 4 x 4

#### **Ejes**

2 ejes motrices y directrices. Eje delantero desconectable para desplazamiento 4x2.

#### **Suspensión**

Montaje rígido al bastidor en el eje delantero. En el eje trasero pivotante. Bloqueo automático de oscilación únicamente con la pluma centrada por la parte frontal.

#### **Neumáticos**

4 de 20.5x25-24 lonas, tipo movimiento de tierras.

#### **Dirección**

Delantera, completamente hidráulica con control por volante. Control independiente del eje trasero para dirección trasera, tipo cangrejo y coordinada.

#### **Frenos**

De Servicio: Hidráulicos de doble circuito, actuando sobre todas las ruedas.

De Aparcamiento: Aplicado por muelle con desconexión hidráulica sobre la transmisión.

#### **Sistema eléctrico**

12 V (dos baterías de 12 V sin mantenimiento).

#### \* Equipos Opcionales

Complimiento de las Directivas Comunitarias.

4 neumáticos 16.00x25-28 lonas (anchura del vehículo 2,54 m.).

Bloqueo cruzado del diferencial

Desconector de baterías.

Gancho de arrastre trasero.

Carrocería de aluminio.

RT530E

GROVE®

\*Otros opcionales a petición

## Torretta

### Braccio

Da 8,8 a 29 m, 4 sezioni con sfilamento completamente idraulico.  
Altezza massima: 31,2 m.

### Sollevamento Braccio

Un cilindro idraulico con valvola di blocco, angolo braccio da  $-3^\circ$  a  $+76^\circ$ .

### Limitatore di carico e blocco dei movimenti

Display grafico standard per limitazione di carico e blocco dei movimenti con allarme visivo e sonoro e controllo dell'esclusione delle leve. Questo sistema è provvisto di display elettronico riportante l'angolo e la lunghezza del braccio, il raggio di lavoro, l'altezza di lavoro, il momento, il peso ammissibile, il peso attuale. Allarme di blocco sui movimenti. Lo standard Work Area Definition System permette all'operatore di preselezionare e definire le aree di lavoro sicure. Se l'autogrù si avvicina ai limiti preselezionati, l'allarme visivo e sonoro aiuta l'operatore a evitare difficoltà sul lavoro.

### Cabina

Costruita in acciaio galvanizzato, insonorizzata, vetro superiore apribile con tergicristallo elettrico e tendina parasole, comodo sedile con comandi integrati nei braccioli, strumentazione ergonomica, comandi sterzo e guida. Riscaldamento ad acqua dipendente dal motore.

### Rotazione

Rotazione continua a  $360^\circ$  con riduttore a planetari con freno a pedale. Freno di parcheggio rilasciato idraulicamente tramite molle e bloccaggio con perno meccanico in una posizione.

### Contrappeso

Da 3.810 kg smontabile, più una piastra al posto del secondo argano.

### Impianto idraulico

3 pompe principali a ingranaggi con capacità totale di 381 l/min. Filtro sul ritorno con protezione by-pass. Raffreddamento olio idraulico con controllo termostatico montato a parte e collegamenti per controllo pressione del sistema. Capacità del serbatoio: 341 l.

### Comandi

Tutti i movimenti della gru sono controllati continuamente con leve di comando a regolazione idraulica per ogni manovra con richiamo automatico al punto zero.

### Argano

Motore a pistoni assiali con riduttore a planetari e freno automatico a dischi. Tamburo scanalato, guide per cavo tamburo argano e indicatore di rotazione elettronico. Fune classe 6x37 per fattore di sicurezza 3,5:1. Indicatore di rotazione argano.

### \*Accessori opzionali

7,9 m di jib ripiegabile (inclinabile da  $0^\circ$  a  $30^\circ$ )  
7,9 m-13,7 m di jib telescopico ripiegabile (inclinabile da  $0^\circ$  a  $30^\circ$ )  
Puleggia supplementare e fune classe 35x7 per fattore di sicurezza 5:1.  
Equipaggiamento con secondo argano (include la testa del braccio ausiliaria)  
Bloccaggio meccanico della rotazione a  $360^\circ$  controllato dalla cabina dell'autogrù.  
Aria condizionata  
Barre luminose LMC

## Carro

### Telaio

Carro speciale, 2 assi, costruzione in acciaio scatolato ad alta resistenza, resistente alla torsione. Occhioni di traino integrati.

### Stabilizzatori

4 travi telescopiche orizzontali idrauliche con cilindri verticali e piatti d'appoggio con una superficie del piatto di 419mm. Comandi indipendenti dei movimenti orizzontali dalla cabina del carro. Tre configurazioni di bloccaggio. Indicatore livello a bolla. Carico massimo piatti stabilizzatori: 22498 kg

### Motore

Cummins 6BT5, 9L, 6 cilindri, turbo 113Kw (152 bhp) a 2500 giri al minuto. Coppia max: 561 Nm a 1500 giri al minuto. Capacità del serbatoio: 220 l. Emissioni gassose allo scarico: EUROMOT/EPA CARB (no su strada). Riscaldamento del blocco motore.

### Cambio

Cambio Dana (Clark) automatico T20000, 6 marce avanti più una retromarcia. Riduttore ripartitore a due velocità e bloccaggio differenziale interassiale.

### Trazione/Sterzo

4x4x4

### Assali

2 assi sterzanti e di trazione. Possibilità di non azionare l'asse anteriore per percorsi 4x2.

### Sospensioni

Asse anteriore montato fisso sul telaio del carro. Asse posteriore articolato. Il dispositivo automatico di bloccaggio sospensioni sblocca la sospensione solo se il braccio è centrato in avanti.

### Pneumatici

4 pneumatici, 20,5x25-24 PR tipo movimento terra.

### Sterzo

Sterzo anteriore completamente idraulico tramite il volante. Sterzo separato dell'asse posteriore per sterzata posteriore, a granchio e combinata.

### Freni

Freno di servizio: idraulico a doppio circuito, agente su tutte le ruote. Freno di parcheggio: con molle precaricate a comando idraulico montato sul cambio.

### Impianto elettrico

12V (2 batterie) da 12V senza manutenzione

### \*Equipaggiamenti opzionali

Certificato CE.  
4 pneumatici, 16.00x25-28PR (larghezza veicolo 2,54 m)  
Differenziale autobloccante  
Disinserimento batteria  
Gancio per rimorchio  
Rivestimento in alluminio

\*Altri a richiesta.

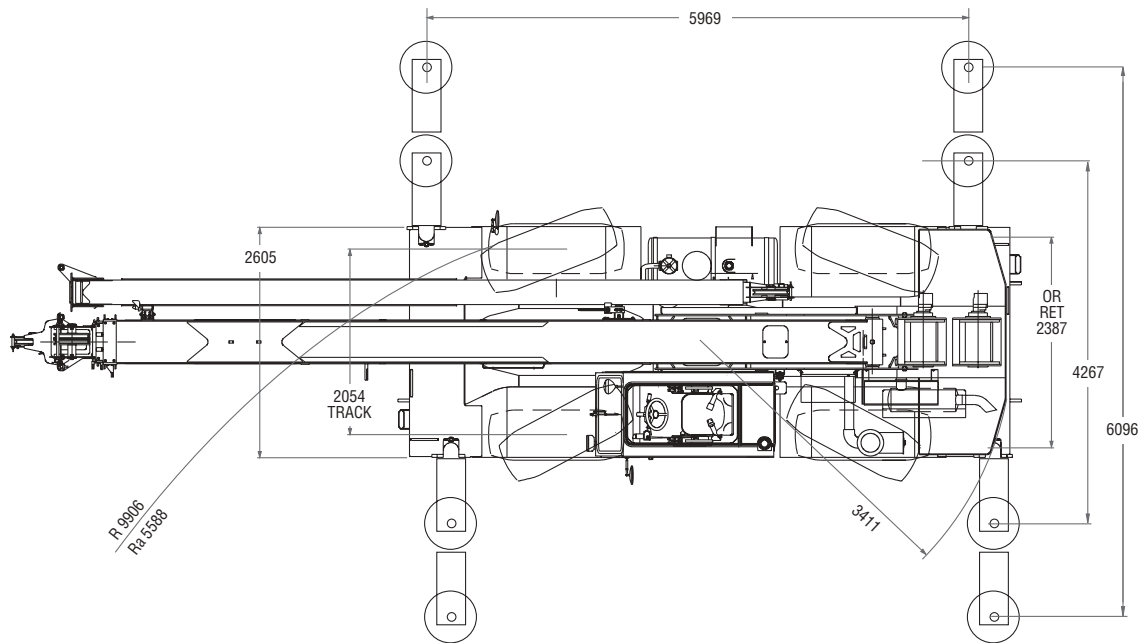
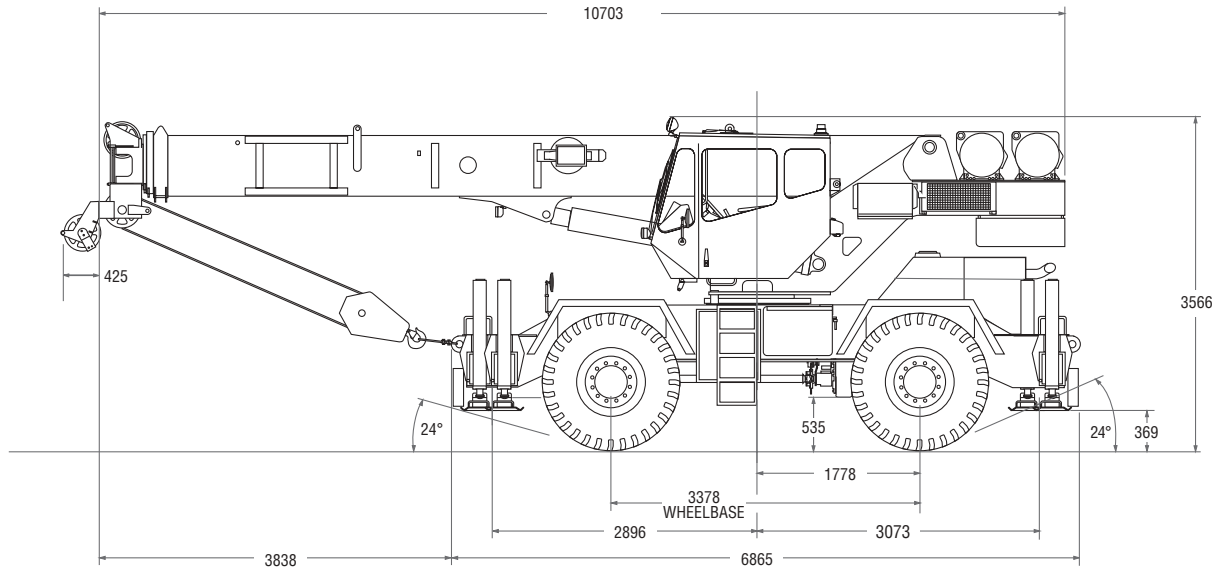

Ra = Radius all wheels steered  
 Radius allradgelenkt  
 Rayon toutes les roues directrices  
 Radio de giro con todas las ruedas giradas  
 Raggio di curva con tutte le ruote sterzate





Axle Achse Essieu Eje Asse	1	2	Total weight Gesamtgewicht Poids total Peso total Peso totale
t	11,4	13,4	24,7







Lifting Capacity Traglast Force de levage Capacidad de elevación Capacità di sollevamento	Sheaves Rollen Poulies Poleas Carrucole	Parts of line Stränge Brins Ramales de cable Numero di funi	Weight Gewicht Poids Peso Peso
30 t	3	2 - 6	270 kg
13.6 t	2	2 - 4	172 kg
6.8 t	H/B (swivel)	1	153 kg
6.8 t	HB	1	161 kg



+







	1 (F & R)	2 (F & R)	3 (F & R)	
km/h	8	17	39	
km/h 	3	7	16	70%
	20.5 x 25			



+



	Infinitely variable stufenlos progressivement variable Infinitamente variable Infinitamente variabile	Rope Seil Câble Cable Fune	Max. permissible line pull Maximal zulässige Seilzugkraft Effort maximum autorisé sur brin simple Potencia máxima admisible por ramal Tiro massimo ammissibile della fune
	0 - 136 m/min single line für einfachen Strang brin simple ramal simple tiro a fune singola	16 mm/137 m (6 x 37 class) ▲ 16 mm/137 m (35 x 7 class)	5339 kg 5280 kg
	0 - 136 m/min single line für einfachen Strang brin simple ramal simple tiro a fune singola	16 mm/137 m (35 x 7 class)	5280 kg
	0 - 2 min <sup>-1</sup>		
	20° to +70° approx. 20 s ca. 20 s env. 20 s aproximadamente 20 s circa 20 s		
	8.8 m to 29.0 m approx. 44 s ca. 44 s env. 44 s aproximadamente 44 s circa 44 s		

▲ Required for 5:1 Rope F.O. S., Gefordert bei 5:1 Sicherheitsfaktor am Hubseil, Nécessaire pour coefficient de sécurité de 5:1 du câble de levage, Necesario para el factor de seguridad de 5 a 1 del cable cabrestante, Necessario per un coefficiente di sicurezza 5:1 della fune di sollevamento.

## Notes • Hinweise • Notes • Notas • Note

### Lifting capacities according to DIN/ISO • 85%

**Warning: THIS CHART IS ONLY A GUIDE. The Notes below are for illustration only and should not be relied upon to operate the crane.**

**The individual crane's load chart, operating instructions and other instruction plates must be read and understood prior to operating the crane.**

DIN/ISO: The mechanical strength complies with DIN 15018, part 3. Tipping conditions are governed by DIN 15019, part 2 and ISO 4305 standards.

They also take into account the requirements of prEN 13000: 1997 and therefore comply with the requirements of the EU machinery directive.

85%: Capacities are in accordance with SAE J1063 and do not exceed 85% of the tipping load (SAE J1289 for outriggers 50% and 0% extended) as determined by SAE J765.

1. Capacities given do not include the weight of hookblocks, slings, auxiliary lifting equipment and load handling devices. Their weights MUST be added to the load to be lifted. When more than minimum required reeving is used, the additional rope weight shall be considered part of the load.
2. All capacities are for crane on firm, level surface. It may be necessary to have structural supports under the outrigger floats or tyres to spread the load to a larger bearing surface.
3. When either boom length or radius or both are between values listed, the smallest load shown at either the next larger radius or boom length shall be used.
4. For outrigger operation, ALL outriggers shall be fully extended with tyres raised free of ground before raising the boom or lifting loads.
5. Tyres shall be inflated to the recommended pressure before lifting on rubber.

### Traglasten entsprechen DIN/ISO • 85%

**WARNUNG: DIESE TABELLE IST LEDIGLICHE EINE RICHTLINIE. Die Hinweise dienen als Erklärung und sind für die Kranbedienung nicht maßgebend. Vor Inbetriebnahme des Kranes sind Traglasttabellen, Bedienungsanleitung und andere Vorschriften eingehend zu studieren.**

DIN/ISO: Der Festigkeitsberechnung liegen die DIN 15018 Teil 3 zugrunde. Die Traglasten im Standsicherheitsbereich entsprechen DIN 15019 Teil 2 und ISO 4305. Sie berücksichtigen außerdem die Forderungen von prEN 13000: 1997 und entsprechen damit den Anforderungen der Maschinenrichtlinie.

85%: Tragkraftwerte entsprechen SAE J1063 und überschreiten nicht 85 % der Kipplast (SAE J1289 bei halb- bzw. ganz ausgefahrener Abstützung) gemäß Richtlinien SAE J 765.

1. Das Gewicht der Hakenflaschen und aller Anschlagmittel muß zu der Last hinzugerechnet werden. Beim Einscheren mit erhöhten Werten ist das zusätzliche Seilgewicht als Teil der Last zu betrachten.
2. Alle Werte gelten für den Kran auf festem, ebenem Untergrund. Eventuell müssen die Stützsteller oder Reifen unterlegt werden, um die Last über eine größere Abstützfläche zu verteilen.
3. Wenn Auslegerlänge oder Radius oder beide Werte zwischen den aufgeführten Werten liegen, ist die geringere der Traglasten zu wählen, die für den die nächstgrößere Ausladung oder die nächste bzw. anschließende Auslegerlänge genannt sind.
4. In abgestütztem Zustand müssen ALLE Stützen komplette ausgefahren sein. Die Reifen dürfen den Boden nicht berühren. Erst danach dürfen Lasten oder der Ausleger angehoben werden.
5. Bevor frei auf Rädern gearbeitet wird, müssen, die Reifen mit dem vorschrittmäßigen Druck aufgefüllt werden.

### Capacités de levage selon DIN/ISO • 85%

**ATTENTION: CE TABLEAU N'EST QU'UN GUIDE. Les notes ci-dessous sont données à titre d'exemple et ne devront pas être utilisées pour faire fonctionner la grue. Toute la documentation concernant chaque type de grue: tableau des charges, instructions de fonctionnement et toutes autres plaques d'instructions devront être lues et comprises avant de manoeuvrer la grue.**

DIN/ISO: Les limites du basculement sont conformes à la norme DIN 15019 section 2 et ISO 4305. Elles tiennent également compte des paramètres établis pour le projet de norme Européenne prEN 13000: 1997 et de ce fait satisfont les exigences de la Directive Européenne Machines.

85%: Les capacités de levage sont conformes à la norme SAE J1063 et ne dépassent pas 85% de la charge de basculement (SAE J1289 pour les poutres de calage déployées à 50% et 0%) tel que cela est prescrit par la norme SAE J765.

1. Les charges mentionnées dans les tableaux ne comprennent pas le poids des mouffes, des élingues et autres accessoires de levage qui doit être additionné à celui de la charge levée. Lorsque le mouffage est supérieur au minimum requis le poids de l'excédent de câble doit être additionné à celui de la charge.
2. Les capacités sont données sur sol ferme et de niveau. Il peut être nécessaire d'utiliser des bastaings ou des accessoires similaires afin de répartir la charge transmise au sol par les roues ou les patins de calage.
3. Lorsque la longueur de flèche ou la portée ne correspond pas aux valeurs mentionnées dans les tableaux, il convient de se référer à la valeur inférieure mentionnée pour la portée ou la longueur de flèche immédiatement supérieure.
4. Pour utilisation machine calée, les poutres de calage doivent être totalement télescopées et les roues décollées du sol avant de relever la flèche ou de lever des charges.
5. Les pneumatiques devront être gonflés aux pressions préconisées avant tout levage en libre.

### Capacidades de elevación de acuerdo con DIN/ISO • 85%

**AVISO: ESTA TABLA ES SOLO UNA ORIENTACION. Las notas que aparecen al final de la misma solo sirven de ilustración y no deben ser tomadas como instrucciones para operar la grúa. La tabla de cargas, las instrucciones de operación y otras placas ilustrativas de cada grúa deben ser leídas y correctamente interpretadas antes de operar la grúa.**

DIN/ISO: Los analisis de resistencia están basados en las normas DIN 15018. Apartados 3. Las condiciones de vuelco están reguladas por las normas

DIN 15019 apartado 2 y ISO 4305. Tienen tambien cuenta de las exigencias establecidas por prEN 13000: 1997 y asi cumplen con los requerimientos de las Directivas de Maquinaria UE.

85%: Capacidades de acuerdo con las Normas SAE J1063 y no exceden del 85% del momento de vuelco (Normas SAE J1289 para las cargas sobre estabilizadores extendidos al 50% o sin extender 0%) como fijan las normas SAE J765.

1. Las cargas indicadas no incluyen el peso de los ganchos, eslingas, equipos auxiliares y aparejos de elevación. Sus pesos DEBEN ser añadidos al de la carga a elevar. Cuando se utilice un número de ramales de cable superior al necesario, el peso adicional del cable debe ser considerado como parte de la carga.
2. Todas las capacidades corresponden a la grúa situada sobre terreno firme nivelado y uniforme. La naturaleza del terreno puede hacer necesario colocar, bajo los apoyos de los estabilizadores o bajo los neumáticos, elementos estructurales que repartan la carga sobre una mayor superficie de apoyo.
3. Cuando se trabaje con longitudes de pluma o radios, intermedios entre los valores reflejados en las tablas, se considerará la carga inmediata inferior indicada en el radio o longitud de pluma inmediato superior.
4. Para trabajos sobre estabilizadores, TODOS los estabilizadores estarán totalmente extendidos y los neumáticos sin tocar el suelo antes de elevar pluma o izar cargas.
5. Los neumáticos deberán estar inflados a la presión recomendada antes de elevar cargas sobre neumáticos.

### Capacità di sollevamento in accordo con DIN/ISO • 85%

**ATTENZIONE: QUESTA TABELLA E' SOLO UNA GUIDA. Le note qui sotto riportate sono date a titolo d'esempio e non devono essere utilizzate per far funzionare la gru.**

**La tabella di carico, le istruzioni d'uso ed ogni altro foglio illustrativo devono essere letti e compresi prima di manovrare la gru.**

DIN/ISO: il calcolo di resistenza è basato sulle norme DIN 15018, parte 3. Le condizioni di ribaltamento sono regolate dalle norme DIN 15019 parte 2 e ISO 4305. Esse tengono conto anche dei parametri stabiliti da prEN13000: 1997 e quindi soddisfanno le richieste della Direttiva Macchine Europea.

85%: Le capacità di sollevamento sono conformi alla norma SAE J1063 e non superano l'85% del carico di ribaltamento (SAE J1289 per gli stabilizzatori estesi al 50% e 0%) come prescritto dalla norma SAE J765.

1. I carichi indicati nelle tavole non comprendono il peso dei ganci, dei tiranti, e di nessun altro accessorio di sollevamento che deve essere aggiunto a quello del carico sollevato. Quando il numero di funi è superiore al minimo richiesto il peso addizionale della fune deve essere aggiunto a quello del carico.
2. Tutte le capacità si intendono per la gru situata su un terreno compatto livellato e uniforme. Potrebbe rendersi necessario utilizzare dei supporti strutturali, sotto gli appoggi degli stabilizzatori o sotto i pneumatici, per ripartire il carico su una superficie di appoggio maggiore.
3. Quando la lunghezza del braccio o la portata non corrispondono ai valori riportati nelle tabelle, conviene considerare il valore inferiore riportato per il raggio di lavoro o la lunghezza del braccio immediatamente superiore.
4. Per lavori su stabilizzatori, TUTTI gli stabilizzatori devono essere completamente estesi e i pneumatici staccati da terra prima di rialzare il braccio o di sollevare carichi.
5. I pneumatici devono essere gonfiati alla pressione raccomandata prima di sollevare carichi sopra i pneumatici.

Load Charts • Traglasten • Capacités de levage • Capacidades • Capacità

Working range • Arbeitsbereiche • Diagramme de levage • Gama de trabajo • Area di lavoro



8.8 – 29.0 m



7.9 – 13.7 m



360°

11

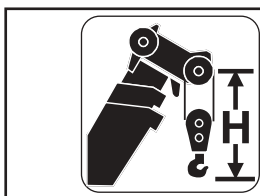
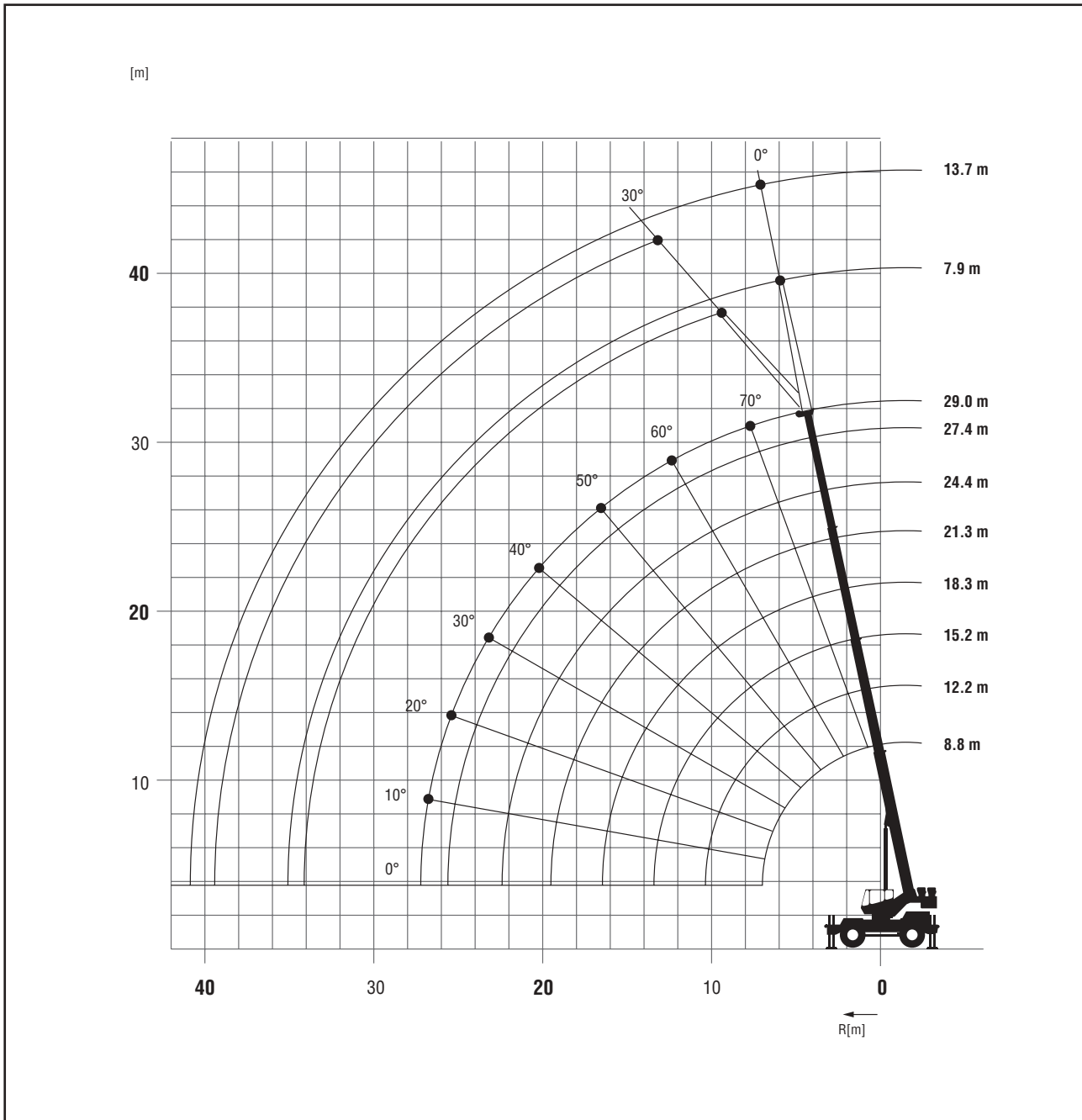

Hook block • Unterflasche • Crochet-moufle • Gancho • Gancio (t)	H (mm)
30	2337
13.6	2337
6.8 H/B	2489
—	—

RT530E

Load Charts • Traglasten • Capacités de levage • Capacidades • Capacità

Telescopic boom • Teleskopausleger • Flèche principale • Pluma telescópica • Braccio telescopico

12



8.8 – 29.0 m



100%



360°



3,810 kg



DIN/ISO

m	8.8	12.2	15.2	18.3	21.3	24.4	27.4	29.0
2.5	30,000							
3.0	27,000	22,700	21,275					
3.5	24,200	22,700	20,625					
4.0	22,050	21,050	19,725	17,600				
4.5	19,850	20,000	18,750	16,350	11,250			
5.0	17,875	18,300	17,125	15,500	10,600	9,525		
6.0	14,250	14,700	14,775	13,550	9,720	8,580	7,375	
7.0		12,300	12,500	11,900	8,845	7,475	6,780	6,395
8.0		10,300	10,500	10,375	7,825	6,890	6,165	5,900
9.0		8,750	8,955	9,055	7,270	6,400	5,760	5,485
10.0		7,530	7,710	7,660	6,810	5,985	5,330	5,125
12.0			5,515	5,505	5,520	5,265	4,715	4,485
14.0				4,110	4,120	4,140	3,685	3,495
16.0				3,135	3,155	3,175	3,200	3,150
18.0					2,450	2,465	2,490	2,505
20.0						1,925	1,950	1,960
22.0						1,490	1,520	1,535
24.0							1,175	1,190
26.0								900

A6-829-102200



85%

m	8.8	12.2	15.2	18.3	21.3	24.4	27.4	29.0
3.0	30,000	22,700	21,275					
3.5	25,650	22,700	20,625					
4.0	22,775	21,050	19,725	17,600				
4.5	19,850	20,000	18,750	16,350	13,350			
5.0	17,875	18,300	17,125	15,500	13,100	10,175		
6.0	14,250	14,700	14,775	13,550	12,425	10,175	8,410	
7.0		12,300	12,500	11,900	11,250	9,330	7,870	7,030
8.0		10,300	10,500	10,375	10,075	8,465	7,245	6,700
9.0		8,750	8,955	9,055	9,040	7,755	6,630	6,075
10.0		7,530	7,785	7,925	7,970	7,145	6,100	5,555
12.0			5,960	6,065	6,075	6,095	5,085	4,620
14.0				4,580	4,590	4,610	4,295	4,020
16.0				3,545	3,565	3,580	3,605	3,420
18.0					2,815	2,830	2,850	2,865
20.0						2,255	2,265	2,290
22.0						1,715	1,820	1,830
24.0							1,455	1,465
26.0								1,160

A6-829-102198

RT530E

GROVE

# Load Charts • Traglasten • Capacités de levage • Capacidades • Capacità

## Telescopic boom • Teleskopausleger • Flèche principale • Pluma telescópica • Braccio telescopico

13



8.8 – 29.0 m



50%



360°



3,810 kg



DIN/ISO

m	8.8	12.2	15.2	18.3	21.3	24.4	27.4	29.0
3.0	27,000	21,750	20,400					
3.5	24,200	21,750	20,375					
4.0	22,050	20,325	18,750	16,775				
4.5	18,550	17,050	15,875	14,875	11,250			
5.0	15,700	14,600	13,700	12,925	10,600	9,525		
6.0	11,200	11,150	10,625	10,100	9,650	8,580	7,375	
7.0		8,405	8,445	8,190	7,855	7,475	6,780	6,395
8.0		6,595	6,645	6,725	6,530	6,295	6,070	5,900
9.0		5,315	5,370	5,455	5,520	5,335	5,155	5,070
10.0		4,345	4,420	4,510	4,465	4,565	4,425	4,355
12.0			3,100	3,195	3,230	3,275	3,320	3,275
14.0				2,320	2,345	2,375	2,410	2,430
16.0				1,690	1,715	1,775	1,760	1,775
18.0					1,240	1,255	1,275	1,285
20.0						885	895	905
22.0						580	595	600

A6-829-100582B



85%

m	8.8	12.2	15.2	18.3	21.3	24.4	27.4	29.0
3.0	27,200	21,750	20,400					
3.5	25,075	21,750	20,375					
4.0	22,350	21,025	19,525	16,775				
4.5	18,725	18,600	17,825	16,350	12,425			
5.0	15,125	15,025	15,000	14,525	12,425	9,525		
6.0	10,725	10,650	10,675	10,700	10,750	9,525	7,710	
7.0		8,085	8,115	8,175	8,280	8,395	7,575	7,030
8.0		6,390	6,430	6,495	6,575	6,665	6,760	6,665
9.0		5,190	5,235	5,305	5,370	5,440	5,515	5,560
10.0		4,275	4,340	4,420	4,470	4,525	4,590	4,620
12.0			3,100	3,185	3,215	3,255	3,295	3,320
14.0				2,320	2,345	2,375	2,410	2,430
16.0				1,690	1,715	1,735	1,760	1,775
18.0					1,240	1,255	1,275	1,285
20.0						885	895	905
22.0						580	595	600

A6-829-100469A

RT530E

Load Charts • Traglasten • Capacités de levage • Capacidades • Capacità

Telescopic boom • Teleskopausleger • Flèche principale • Pluma telescópica • Braccio telescopico

14



8.8 – 29.0 m



0%



360°



3,810 kg



DIN/ISO

m	8.8	12.2	15.2	18.3	21.3	24.4	27.4	29.0
3.0	14,375	13,125	12,100					
3.5	11,625	10,850	10,125					
4.0	9,655	9,165	8,620	8,105				
4.5	8,155	7,820	7,435	7,035	6,660			
5.0	6,895	6,750	6,490	6,165	5,860	5,570		
6.0	4,990	4,945	4,970	4,835	4,620	4,415	4,225	
7.0		3,715	3,750	3,810	3,710	3,560	3,415	3,340
8.0		2,845	2,890	2,960	3,010	2,900	2,785	2,730
9.0		2,195	2,250	2,325	2,385	2,375	2,285	2,240
10.0		1,685	1,755	1,835	1,885	1,930	1,875	1,835
12.0			1,040	1,130	1,160	1,200	1,220	1,205
14.0				645	665	690	725	730

A6-829-100691



85%

m	8.8	12.2	15.2	18.3	21.3	24.4	27.4	29.0
3.0	16,125	15,000	14,075					
3.5	12,275	12,125	11,575					
4.0	9,760	9,630	9,585	9,295				
4.5	7,990	7,890	7,865	7,870	7,665			
5.0	6,690	6,605	6,600	6,615	6,695	6,440		
6.0	4,900	4,845	4,855	4,890	5,010	5,055	4,885	
7.0		3,685	3,710	3,760	3,850	3,945	3,925	3,865
8.0		2,845	2,890	2,960	3,030	3,110	3,190	3,150
9.0		2,195	2,250	2,325	2,385	2,455	2,530	2,570
10.0		1,685	1,755	1,835	1,885	1,945	2,005	2,040
12.0			1,040	1,130	1,160	1,200	1,245	1,270
14.0				645	665	690	725	745

A6-829-100470

RT530E

GROVE

# Load Charts • Traglasten • Capacités de levage • Capacidades • Capacità

## Telescopic boom • Teleskopausleger • Flèche principale • Pluma telescópica • Braccio telescopico



8.8 – 18.3 m



20.5 x 25



360°



3,810 kg

15



DIN/ISO

m	0 kph				< 4 kph			
	8.8	12.2	15.2	18.3	8.8	12.2	15.2	18.3
	360°				0°			
3.0	11,550	10,575	9,340		11,725	11,725	8,275	
3.5	9,445	8,825	8,190		10,500	10,500	8,275	
4.0	7,875	7,450	7,010		9,385	9,385	8,275	
4.5	6,470	6,370	6,065	5,705	8,415	8,415	8,275	6,050
5.0	5,335	5,350	5,270	5,000	7,565	7,565	7,565	6,050
6.0	3,660	3,675	3,685	3,695	6,190	6,190	6,190	6,050
7.0		2,650	2,660	2,665		4,945	4,955	4,965
8.0		1,980	1,990	2,000		3,920	3,930	3,935
9.0		1,495	1,505	1,515		3,170	3,180	3,185
10.0		1,125	1,135	1,145		2,600	2,610	2,615
12.0			610	615			1,705	1,800
14.0								1,250
16.0								885

A6-829-100565B

A6-829-100566B



85%

m	0 kph				< 4 kph			
	8.8	12.2	15.2	18.3	8.8	12.2	15.2	18.3
	360°				0°			
3.0	11,575	11,575	7,460		11,725	11,725	8,275	
3.5	10,175	10,025	7,460		10,500	10,500	8,275	
4.0	8,850	8,850	7,460		9,385	9,385	8,275	
4.5	7,590	7,590	7,460	7,460	8,415	8,415	8,275	6,050
5.0	6,305	6,305	6,305	6,305	7,565	7,565	7,565	6,050
6.0	4,405	4,405	4,405	4,405	6,190	6,190	6,190	6,050
7.0		3,240	3,240	3,240		5,180	5,180	5,180
8.0		2,485	2,485	2,485		4,430	4,430	4,430
9.0		1,930	1,930	1,930		3,820	3,820	3,820
10.0		1,510	1,510	1,510		3,315	3,315	3,315
12.0			915	915			2,505	2,505
14.0				510				1,265
16.0								885

A6-829-100474

A6-829-100475

m	0 kph			
	8.8	12.2	15.2	18.3
	0° (± 6°)			
3.0	13,650	12,025	7,460	
3.5	12,425	10,025	7,460	
4.0	11,225	10,025	7,460	
4.5	10,175	10,025	7,460	7,460
5.0	9,225	9,225	7,460	7,460
6.0	7,610	7,610	7,460	7,460
7.0		6,005	6,005	6,005
8.0		5,125	5,125	5,125
9.0		4,260	4,260	4,260
10.0		3,535	3,535	3,535
12.0			2,505	2,505
14.0				1,705
16.0				1,210

A6-829-10473

0° = over front, über Vorderkante, sur avant, par la parte frontal, per la parte frontale

RT530E

GROVE®

# Load Charts • Traglasten • Capacités de levage • Capacidades • Capacità

## Swingaway • Klappspitze • Extension treillis • Plumin • Jib

16



29.0 m



7.9 – 13.7 m



100%



360°



3,810 kg



DIN/ISO

29.0					
m	* 7.9			13.7	
	0°	30°		0°	30°
9.0	3,265				
10.0	3,060			2,380	
12.0	2,710	2,425		2,300	
14.0	2,375	2,185		2,040	
16.0	2,105	1,990		1,860	1,235
18.0	1,890	1,825		1,675	1,235
20.0	1,705	1,655		1,520	1,230
22.0	1,540	1,530		1,370	1,155
24.0	1,180	1,365		1,270	1,120
26.0	885	1,040		1,165	1,060
28.0	635	765		970	995
30.0		530		755	935
32.0				565	760
34.0					565

A6-829-100581A



85%

29.0					
m	* 7.9			13.7	
	0°	30°		0°	30°
9.0	3,715				
10.0	3,715			2,380	
12.0	3,715	2,620		2,380	
14.0	3,615	2,585		2,205	
16.0	3,110	2,290		1,970	1,235
18.0	2,630	1,985		1,785	1,235
20.0	2,150	1,735		1,685	1,230
22.0	1,800	1,540		1,605	1,155
24.0	1,465	1,385		1,495	1,120
26.0	1,130	1,250		1,375	1,095
28.0	865	1,015		1,225	1,080
30.0	660	770		1,000	1,055
32.0				790	905
34.0				610	670

A6-829-100471

RT530E

GROVE

\* 7.9 m capacities are also applicable to fixed length offsettable swingaway, 7.9 m Traglasten gelten auch für starre, abwinkelbare Klappspitze. Les capacités de levage sur extension treillis de 7.9 m sont aussi valables pour l'extension treillis inclinable non télescopique. Las capacidades de este plumin de 7.9 m. son también aplicables al plumin de longitud fija no angular. Le capacità di 7.9m sono applicabili anche alla lunghezza del jib fisso.



# Load Charts • Traglasten • Capacités de levage • Capacidades • Capacità

## Swingaway • Klappspitze • Extension treillis • Plumin • Jib



29.0 m



7.9 – 13.7 m



50%



360°



3,810 kg

17



29.0				
m	* 7.9		13.7	
	0°	30°	0°	30°
9.0	3,265			
10.0	3,060		2,380	
12.0	2,710	2,425	2,300	
14.0	2,150	2,185	2,040	
16.0	1,605	1,990	1,860	1,235
18.0	1,180	1,515	1,445	1,235
20.0	840	1,115	1,110	1,230
22.0	555	790	835	1,155
24.0		515	600	965
26.0				720
28.0				505

A6-829-100583A



29.0				
m	* 7.9		13.7	
	0°	30°	0°	30°
9.0	3,715			
10.0	3,715		2,380	
12.0	3,235	2,620	2,380	
14.0	2,430	2,585	2,205	
16.0	1,825	2,215	1,970	1,235
18.0	1,355	1,630	1,640	1,235
20.0	960	1,175	1,270	1,230
22.0	630	810	960	1,155
24.0		515	685	1,090
26.0			500	785
28.0				525

A6-829-100472

\* 7.9 m capacities are also applicable to fixed length offsettable swingaway, 7.9 m Traglasten gelten auch für starre, abwinkelbare Klappspitze, Les capacités de levage sur extension treillis de 7.9 m sont aussi valables pour l'extension treillis inclinable non télescopique, Las capacidades de este plumin de 7.9 m. son también aplicables al plumin de longitud fija no angulable, Le capacità di 7.9m sono applicabili anche alla lunghezza del jib fisso.

**Weight reductions • Gewichte der Lastaufnahmemittel • Reductions de charge  
Reducciones de peso • Riduzioni di peso**

18

<b>Auxiliary boom nose</b> / Zusatz-Auslegerkopf / <i>Tête de flèche auxiliaire</i> / Cabeza auxiliar / Falconcino ausiliario in testa al braccio	64 kg
<b>Hookblocks</b> / Hakenflaschen / <i>Moufles</i> / Ganchos / Ganci	
<b>30 tonne 4 sheave</b> / Seilrollen / <i>réas / poleas / carrucole</i>	TBA
<b>30 tonne 3 sheave</b> / Seilrollen / <i>réas / poleas / carrucole</i>	263 kg
<b>13.6 tonne 1 sheave</b> / Seilrollen / <i>réas / poleas / carrucole</i>	193 kg
<b>6.8 tonne swivel hook and weight</b> / Hakengeschrir / <i>crochet lesté / gancho y bola / gancio &amp; peso</i>	153 kg
<b>6.8 tonne hook and weight</b> / Hakengeschrir / <i>crochet lesté / gancho y bola / gancio &amp; peso</i>	161 kg
<b>7.9 m Extension / Klappspitze</b> / <i>Prolongacion / Estensione</i>	
<b>Erected</b> / Arbeitsstellung / <i>En position de travail / Montado / Montato</i>	1,343 kg
<b>7.9 m – 13.7 m Extension / Klappspitze</b> / <i>Prolongacion / Estensione</i>	
<b>Erected</b> / In Arbeitsstellung / <i>En position de travail / Montado / Montato (7.9 m)</i>	1,914 kg
<b>Erected</b> / In Arbeitsstellung / <i>En position de travail / Montado / Montato (13.7 m)</i>	2,622 kg

**NOTE:**  
All load handling devices and boom attachments are considered part of the load and suitable allowances must be made for their combined weights.

**HINWEIS:**  
Alle Lastaufnahmemittel und jede Zusatzausrüstung des Hauptauslegers werden als Teil der Traglast betrachtet und ihre kombinierten Gewichte müssen beim Feststellen der Nettolast entsprechend berücksichtigt (abgezogen) werden.

**REMARQUE:**  
Les équipements complémentaires et accessoires de levage sont considérés comme faisant partie de la charge; les réductions de charges de leurs poids combinés doivent être effectuées.

**NOTA:**  
Todos los aparjos de elevacion e implementos de pluma son considerados parte de la carga y deben ser tenidos en cuenta para calcular los pesos a elevar.

**NOTA:**  
Tutti gli accessori di sollevamento e le opzioni montate sul braccio sono considerati parte del carico e devono essere richieste adeguate autorizzazioni per l'uso dei loro pesi complessive.

Symbols • Symbolerklärung • Glossaire des symboles • Glosario de simbolos • Glossario dei simboli



Axles  
Achsen  
Ponts  
Ejes  
Assali



Crane functions  
Kranbewegungen  
Mouvements de la grue  
Funciones de la grúa  
Funzioni della gru



Hookblock / Capacity  
Hakenflasche / Traglast  
Moufle / Force de levage  
Gancho / Capacidad  
Gancio / Capacità



Speed  
Geschwindigkeit  
Vitesse  
Velocidad  
Velocità



Axle load  
Achslast  
Charge à l'essieu  
Carga por eje  
Carico sugli assi



Crane travel  
Fahrstellung  
Déplacement de la grue  
Grúa en traslado  
Traslazione gru



Hydraulic system  
Hydrauliksystem  
Circuit hydraulique  
Sistema hidráulico  
Impianto idraulico



Suspension  
Federung  
Suspension  
Suspension  
Sospensioni



Boom  
Ausleger  
Flèche  
Pluma  
Braccio



Drive/Steer  
Antrieb/Lenkung  
Direction/Déplacement  
Tracción/Dirección  
Trazione/Sterzo



Lattice extension  
Gitterspitze  
Extension treillis  
Extensión de celosía  
Lunghezza prolunga



Transmission / Gear  
Getriebe / Gang  
Boîte de vitesses / Rapport  
Transmisión / Cambio  
Cambio



Boom elevation  
Wippwerk  
Relevage  
Elevacion de pluma  
Elevazione braccio



Electrical system  
Elektrische Anlage  
Circuit électrique  
Sistema eléctrico  
Impianto elettrico



Lattice extension (luffing)  
Auslegerverlängerung (wippbar)  
Extension treillis (volée variable)  
Extensión de celosía (angularmente hidráulicamente)



Travel speed  
Fahrgeschwindigkeit  
Vitesse de déplacement  
Velocidad de desplazamiento  
Velocità di traslazione



Boom telescoping  
Teleskopieren  
Télescopage de flèche  
Telescopaje de pluma  
Lunghezza braccio



Engine  
Motor  
Moteur  
Motor  
Motore



Luffing Jib  
Wippspitzenausleger  
Volée variable  
Plumín angularable



Tyres  
Bereifung  
Pneumatiques  
Neumáticos  
Pneumatici



Brakes  
Bremsen  
Freins  
Frenos  
Freni



Free on wheels  
Freistehend  
Sur pneus  
Sobre neumáticos  
Su gomme



Low range  
Kleinste Übersetzung  
Gamme basse  
Marchas cortas  
Fuoristrada



Cab  
Kabine  
Cabine  
Cabina  
Cabina



Gradeability  
Steigfähigkeit  
Aptitude en pente  
Superacion de pendientes  
Pendenza superabile



Outriggers  
Abstützung  
Calage  
Estabilizadores  
Stabilizzatori



Carrier frame  
Rahman  
Châssis porteur  
Bastidor  
Telaio



Main hoist  
Haupthubwerk  
Treuil principal  
Cabrestante principal  
Argano principale



Radius  
Ausladung  
Portée  
Radio  
Raggio



Counterweight  
Gegengewicht  
Contrepoids  
Contrapeso  
Contrappeso



Auxiliary hoist  
Hilfshubwerk  
Treuil auxiliaire  
Cabrestante auxiliar  
Argano secundario



Slewing/Working range  
Drehwerk/Arbeitsbereich  
Orientation/Rayon d'operation  
Giro/Gamma de trabajo  
Rotazione/Area di lavoro



**Manitowoc Crane Group - Americas**

Tel: [Int + 001] 920 684 6621  
Fax: [Int + 001] 920 683 6277

**Manitowoc Crane Group - EMEA**

Europe Middle East & Africa  
Tel: [Int + 33] (0) 4 72 18 20 20  
Fax: [Int + 33] (0) 4 72 18 20 00

**Manitowoc Crane Group - UK**

Europe Middle East & Africa (Parts & Service)  
Tel: [Int + 44] (0) 191 565-6281  
Fax: [Int + 44] (0) 191 564-0442

**Manitowoc Crane Group - Germany**

(Sales, Parts & Service)  
Tel: [Int + 49] (0) 2173 8909-0  
Fax: [Int + 49] (0) 2173 8909-30

**Manitowoc Crane Group - France**

France & Africa (Sales, Parts & Service)  
Tel: [Int + 33] (0) 1 303-13150  
Fax: [Int + 33] (0) 1 303-86085

**Manitowoc Crane Group - Netherlands**

(Sales, Parts & Service)  
Tel: [Int + 31] (0) 76 578 39 99  
Fax: [Int + 31] (0) 76 578 39 78

**Manitowoc Crane Group - Italy**

Italy & Southern Europe (Sales, Parts & Service)  
Tel: [Int + 39] (0) 331 49 33 11  
Fax: [Int + 39] (0) 331 49 33 30

**Manitowoc Crane Group - Portugal**

Portugal & Spain (Sales, Parts & Service)  
Tel: [Int + 351] (0) 22 968 08 89  
Fax: [Int + 351] (0) 22 968 08 97

**Manitowoc Crane Group - Singapore**

Asia/Pacific excl China (Sales, Parts & Service)  
Tel: [Int + 65] 6861-7133  
Fax: [Int + 65] 6862-4040 / 4142

**Manitowoc Crane Group - Shanghai**

China (Sales, Parts & Service)  
Tel: [Int + 86] (0) 21-64955555  
Fax: [Int + 86] (0) 21-64852038

**Manitowoc Crane Group - Beijing**

China (Sales, Parts & Service)  
Tel: [Int + 86] (0) 10 646-71690  
Fax: [Int + 86] (0) 10 646-71691

**Manitowoc Crane Group - Middle East**

(Sales)  
Tel: [Int + 971] (0) 4 348-4478  
Fax: [Int + 971] (0) 4 348-4478

(Parts & Service)  
Tel: [Int + 973] (0) 9 660-899  
Fax: [Int + 973] (0) 2 707-740

**Distributed By:**



[www.manitowoccrane.com](http://www.manitowoccrane.com)



Constant improvement and engineering progress make it necessary that we reserve the right to make specification, equipment, and price changes without notice. Illustrations shown may include optional equipment and accessories and may not include all standard equipment.

Wir verbessern unsere Produkte ständig und integrieren den technischen Fortschritt. Aus diesem Grund behalten wir uns das Recht vor, die technischen Daten, die Ausstattungsdetails und die Preise unserer Maschinen ohne Vorankündigung zu ändern.

Du fait de sa politique d'amélioration constante de ses produits liée au progrès technique, la Société se réserve le droit de procéder sans préavis à des changements de spécifications, d'équipement ou de prix. Les illustrations peuvent comporter des équipements ou accessoires optionnels ou ne pas comporter des équipements standards.

El perfeccionamiento constante y el avance tecnológico hacen necesario que la empresa se reserve el derecho de efectuar cambios en las especificaciones, equipo y precios sin previo aviso. En las ilustraciones se puede incluir equipo y accesorios opcionales y es posible que no se muestre el equipo normal.

Dati e caratteristiche possono variare senza obbligo di preavviso.