

To learn more about this model, call 414-764-9200 or visit [giuffre.com](http://giuffre.com) today!

**Manitex**



TC220

22-Ton (20 mt) TELESCOPIC CRANE  
TC220 SERIES PRODUCT GUIDE



AVAILABLE AT:

**GIUFFRE.COM**

GIUFFRE BROS CRANES INC.

6635 SOUTH 13TH ST. - MILWAUKEE, WI 53221  
414-764-9200 • 877-321-3710

To learn more about this model, call 414-764-9200 or visit [giuffre.com](http://giuffre.com) today!

TC220 SERIES TELESCOPIC CRANE

CONTENTS

Crane Features .....	4
Chassis Data .....	5
Outrigger Extension.....	7
Sub Frame .....	7
Electrical System .....	7
22101S Load Chart: Main Boom .....	8
22101S Load Chart: Main Boom .....	9
2277S Load Chart: Main Boom .....	10
2277S Boom Diagram .....	11
Area of Operation .....	12
Reeving Diagram.....	12
LMI Codes .....	13
Warning, Information & Definitions .....	13
Technical Descriptions .....	14
Options .....	15

Effective Date: September 1, 2014

This document is non-contractual. This document is supplied for reference use only. We are constantly making improvements to our products and reserve the right that specification, equipment, and prices are all subject to change without notice or obligation.

The photographs, and /or images in this document are for illustrative purposes only and may include optional equipment and accessories and may not include all standard equipment.

Refer to the appropriate Operator's Manual and Load Charts for instructions on the proper use of this equipment to determine allowable crane lifting capacities, assembly and operating procedures.

Failure to follow the appropriate operator's manual or load chart(s) when using our equipment or to otherwise act irresponsibly may result in serious injury or death.

The only warranty applicable to our equipment is the standard written warranty applicable to the particular product and sale. Manitex makes no other warranty, expressed or implied.

Products and services listed may be trademarks, service marks or trade-names of Manitex International and /or its subsidiaries in the USA and other countries.

All rights are reserved. Manitex® is a registered trademark of Manitex International, Inc. in the USA and many other countries.

Copyright 2013 Manitex Inc. Manitex Inc, Georgetown Texas, 7862



AVAILABLE AT:



















**GIUFFRE.COM**

















GIUFFRE BROS CRANES INC.

6635 SOUTH 13TH ST. - MILWAUKEE, WI 53221

414-764-9200 • 877-321-3710

## KEY

	Operator aids
	Cab
	Heating / Air conditioning
	Controls
	Hoist speed
	1 - Main hoist 2 - Auxiliary winch 3 - Recovery winch
	Rope length
	Rope - standard/optional
	Rope diameter
	Permissible line pull
	Maximum line pull
	Slewing / Allowable slewing range
	Slewing gears
	Slewing brake
	Outriggers / Lifting on outriggers
	2-Person man basket
	Counterweight
	Radio remote control

	Hook block
	Distance from hook to head sheave pin
	Hook and ball
	Hydraulics
	Boom elevation angle
	Max. boom length with extension
	Boom with extension retracted
	Boom angle
	Telescoping mode
	Working radius
	Boom length
	Hydraulic actuated boom
	Full power mechanical synchronized
	Boom head / Hook block dimension
	Main boom with auxiliary head
	Tip height

To learn more about this model, call 414-764-9200 or visit [giuffre.com](http://giuffre.com) today!

TC220 SERIES TELESCOPIC CRANE



## THE TC220 SERIES TELESCOPIC CRANES

Versatile. Affordable. User friendly.

The TC220 series telescopic cranes are built to meet the wide-ranging needs of owner operators who may use it for residential construction one day and bridge work the next. No matter what the task, the 22-ton line of telescopic crane is designed to get you to the job and on the job quickly.

With it, you can:

- Travel to and between job sites at highway speed on a commercial chassis

### Other features include:

- 22-ton capacity @ 5 ft. radius
- 3, 4-section proportional boom
- Optional telescopic jib
- 139'-10" (42,6m) maximum tip height (with optional jib)
- Optional Basic Cab
- Out-and-down outriggers

### OUT & DOWN OUTRIGGER

Four Out & Down Outriggers with Audible Outrigger Motion Alarm sounds as outriggers are being deployed and indicator lights verify when they are fully extended.



### TWO-SPEED PLANETARY HOIST

Increase productivity and minimize downtime. The two-speed planetary hoist lets you change line speed on the fly and minimize rope stacking.

### LOAD MOMENT INDICATOR

The Load-moment indicator sounds a warning or shuts down the machine when lift limitations are about to be exceeded.

### INCREASE PROFITABILITY

The versatile TC220 series is designed to help both owners and operators make the most of their investment.

- Travel to and between jobs at highway speed.
- Minimize maintenance costs with replaceable, self-lubricating boom slider pads and sealed, multi-disc wet brakes on the hoist and swing system.



## TC220 SERIES CHASSIS DATA

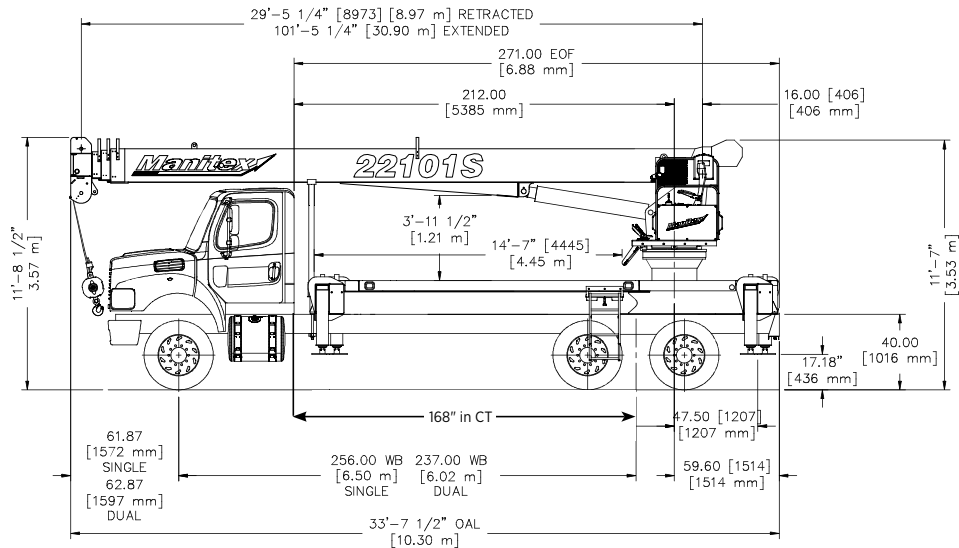

### CHASSIS DATA

S Models	22101S Single Axle	22101S Tandem Axle
Wheel Base (WB)	256 in. (6,502 mm)	237 in. (6,020 mm)
Cab to Axle (CA)	186 in. (4,724 mm)	-
Cab to Tandem (CT)	-	168 in. (4,267 mm)
Frame section modulus at 180° area of operation*	15.9 in <sup>3</sup> , 110,000 psi, 758,422 kPa	15.9 in <sup>3</sup> , 110,000 psi, 758,422 kPa
Cab to End of Frame (EOF)	271" (6,883 mm)	271" (6,883 mm)
Nominal Frame Width	34 in. (864 mm)	34 in. (864 mm)

\* Frame selection modulus at 360° area of operation requires front bumper stabilizer.

### TRUCK AXLE WEIGHTS

S Models	22101S Single Axle	22101S Tandem Axle
Front axle (FAWR)	Consult Factory	16,000 lbs. (7,257 kg)
Rear axle (RAWR)	Consult Factory	40,000 lbs. (18,143 kg)
Min. truck axle W - Front**	Consult Factory	6,800 lbs. (3,084 kg)
Min. truck axle W - Rear**	Consult Factory	7,400 lbs. (3,765 kg)

\*\* Minimum chassis weight is required to meet 85% stability requirements. Chassis data is general - not for engineering. Some dimensions depend on truck selection.

### CRANE WEIGHTS

Model	22101S
Crane without cab	18,903 lb. (8,574 kg)
Cab	575 lb., (261 kg)
Flatbed 13 ft.	1,200 lb. (544 kg)
Jib Fixed	660 lb. (299 kg)

Data published herein is intended as a guide only. Crane operation is subject to machine specific load charts and information.

TC220 SERIES TELESCOPIC CRANE

## TC220 SERIES CHASSIS DATA: //

### 2277S Dimensions

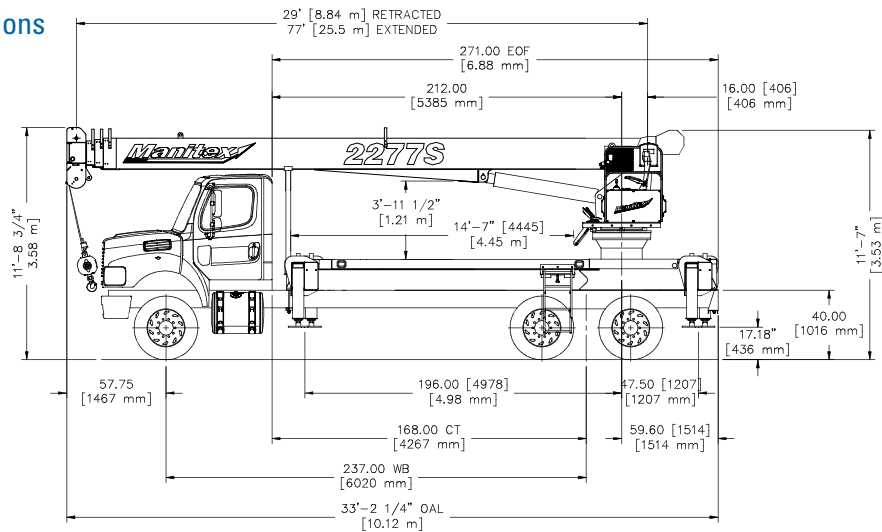

### CHASSIS DATA

2277S Tandem Axle	
Wheel Base (WB)	237 in. (5,020 mm)
Cab to Tandem (CT)	168 in. (4,267 mm)
Cab to End of Frame (EOF)	271 in. (6,883 mm)
Nominal frame width	34 in. (864 mm)
Frame section modulus	15.9 in <sup>3</sup> , 110,000 psi 758,422 kPa

### TRUCK AXLE WEIGHT

Model	2277S Tandem Axle
Front axle (FAWR)	16,000 lbs. (7,257 kg)
Rear axle (RAWR)	40,000 lbs. (18,143 kg)
Min. truck axle weight - Front**	5,750 lbs. (2,608 kg)
Min. truck axle weight - Rear**	6,750 lbs. (3,062 kg)

\*\* Minimum chassis weight is required to meet 85% stability requirements. Chassis data is general - not for engineering. Some dimensions depend on truck selection.

### CRANE WEIGHTS

Model	2277S
Crane without cab	17,579 lb. (7,973 kg)
Cab	575 lb., (261 kg)
Flatbed 13 ft.	1,200 lb. (544 kg)
Jib Fixed	660 lb. (299 kg)

Data published herein is intended as a guide only. Crane operation is subject to machine specific load charts and information.

## OUTRIGGER EXTENSION

Full Extension

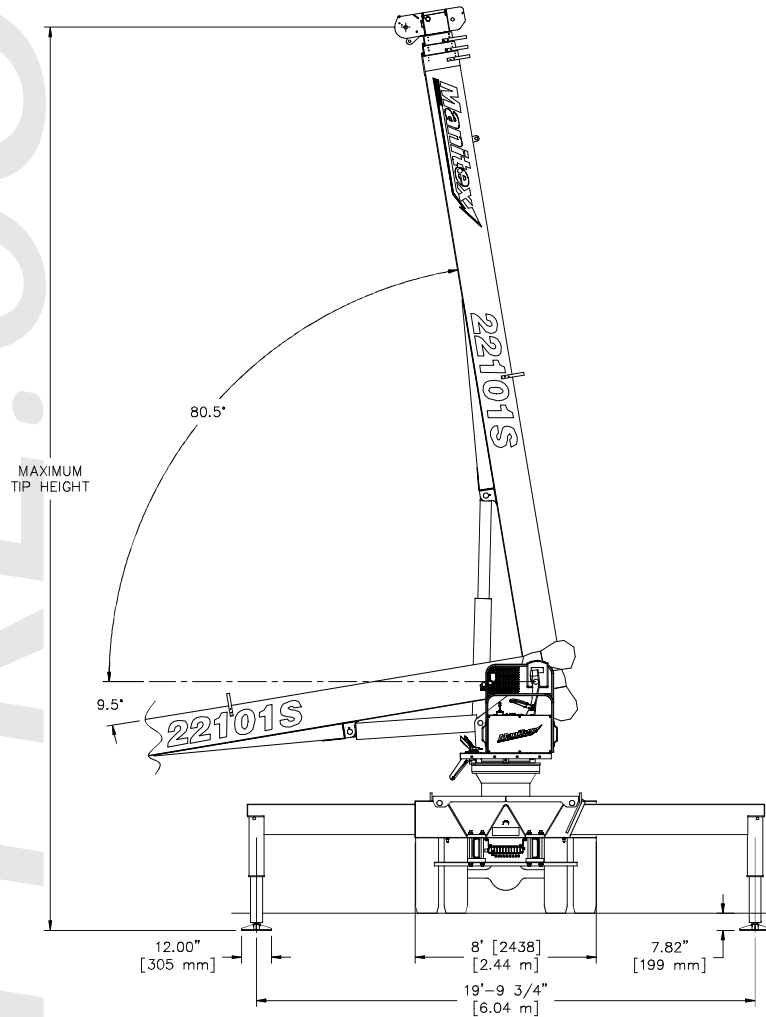

### SUB FRAME

- Pedestal sub-frame and stabilizers are mounted to chassis by threaded rods and clamp plates
- Sub-frame: Torsion resistant, rigid 4-plate design mounted under crane full length of truck frame
- Rear under-ride protection: Standard on factory mounted cranes

### ELECTRICAL SYSTEM

- 12-Volt Electrical System
- State-of-the-art, weather-resistant components throughout
- Hermetically sealed enclosure includes power in relays and circuit status LEDs

Data published herein is intended as a guide only. Crane operation is subject to machine specific load charts and information.

TC220 SERIES TELESCOPIC CRANE

# 22101S LOAD CHART: Main Boom & Jib

Lifting Capacities 4 section Boom 29.4 ft. - 101.4 ft.

 19' 9 3/4" (6 m)

LMI Tandem Axle Load Chart  
Full Outrigger Extension

Load Ratings in (lbs.) with Outriggers Fully Extended										Jib Load Ratings in (lbs.)			
Loaded Boom Angle (ft.)	LMI Code #1	Boom length & Marker	LMI Code #1							Loaded Boom Angle (ft.)	Fixed Jib		
			A (lbs.)		B (lbs.)		C (lbs.)		D (lbs.)		LMI Code #2		
			53 ft.	69 ft.	85 ft.	101.4 ft.	Jib Length for All Boom Lengths See Warning Note: 4						
5	80	44,000								8	29.4 ft.		
8	74	33,540								10			
10	70	28,140								12			
12	66	24,230	78	14,000						14			
14	61	20,460	76	14,000	80	14,000				17			
17	54	16,400	72	14,000	78	12,880				20			
20	46	13,520	69	13,700	75	11,430	79	8,920		25			
25	29	10,210	63	10,600	71	9,460	75	8,000	79	6,000	25		
30			56	8,390	66	8,210	72	7,070	76	5,500	30	80	3,000
35			49	6,790	61	6,890	68	6,130	73	4,980	35	78	2,840
40			41	5,590	56	5,700	65	5,320	70	4,490	40	76	2,620
45			31	4,640	51	4,760	61	4,640	67	4,000	45	73	2,420
50			17	3,880	45	4,000	57	4,070	64	3,580	50	71	2,230
55					38	3,380	52	3,450	61	3,200	55	69	2,020
60					30	2,860	47	2,930	57	2,850	60	67	1,840
65					19	2,410	42	2,490	54	2,520	65	64	1,670
70							36	2,090	50	2,130	70	62	1,520
75							29	1,740	45	1,790	75	59	1,380
80							20	1,440	41	1,500	80	56	1,230
85									36	1,240	85	53	1,080
90									30	1,020	90	50	950
95									22	820	95	47	830
100											100	44	720
105											105	40	570
110											110	36	430
		340 lbs.		190 lbs.		150 lbs.		120 lbs.		100 lbs.	Deductions for Stowed Jib		

**NOTES:**

- Loads based on crane on outriggers
- All loads are based on 85% tipping
- Loads above heavy line are based on structural rating
- Loads below heavy line are based on tipping rating

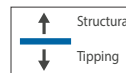

Data published herein is intended as a guide only. Crane operation is subject to machine specific load charts and information.



## 22101S BOOM DIAGRAM

- FULLY EXTENDED OUTRIGGER CONFIGURATION -

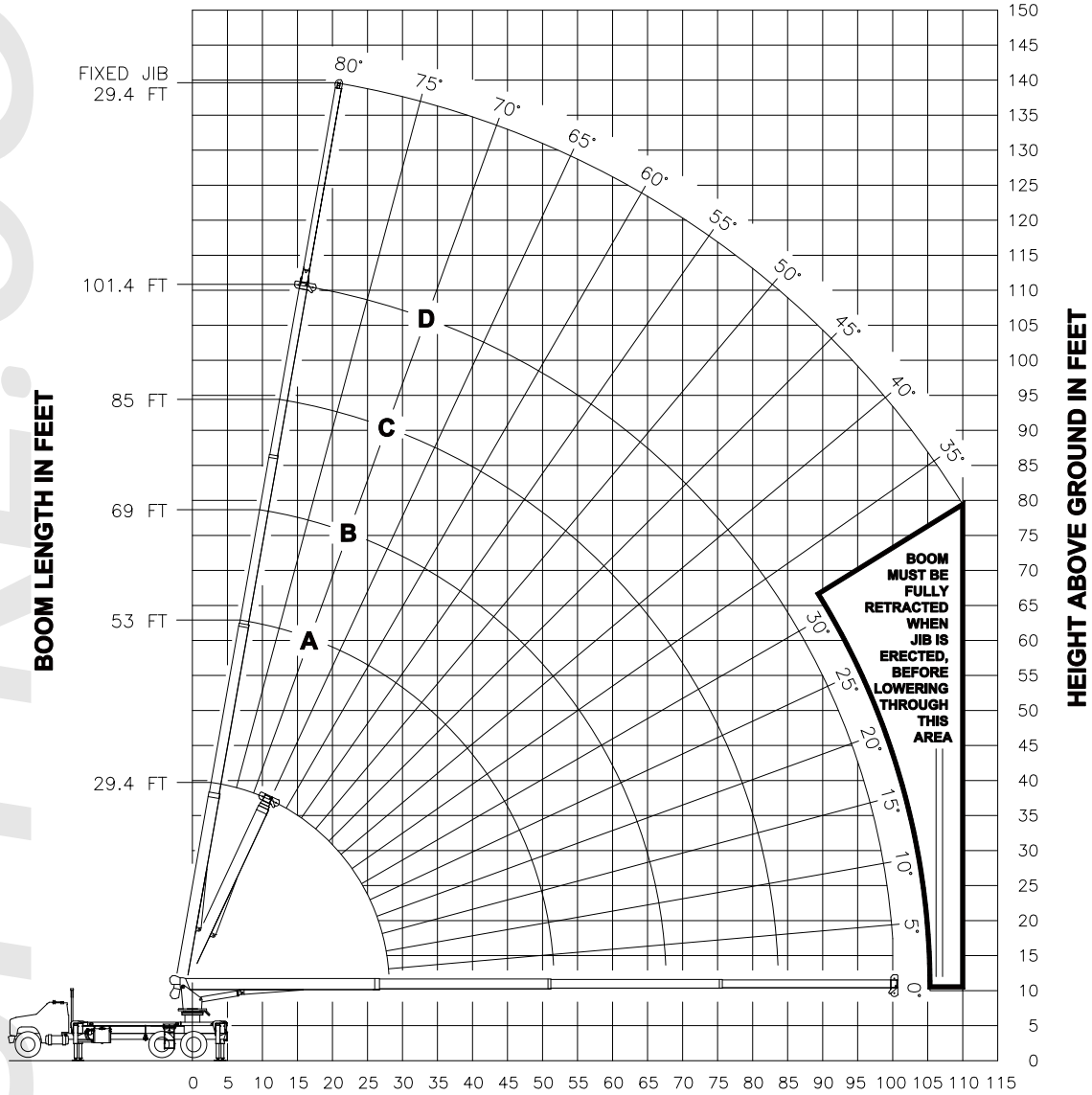

Data published herein is intended as a guide only. Crane operation is subject to machine specific load charts and information.

TC220 SERIES TELESCOPIC CRANE

# 2277S LOAD CHART: Main Boom & Jib

Lifting Capacities 3-Section Boom 29 ft. - 77 ft.  
Full Outrigger Extension

 19' 9 3/4" (6 m)

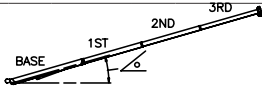
Load Ratings in (lbs.) with Outriggers Fully Extended										Jib Load Ratings in (lbs.)						
LMI Code #1																
Loaded Boom Angle (ft.)	Boom length & Marker									Loaded Boom Angle (ft.)	Fixed Jib		Telescopic Jib			
		A (lbs.)	B (lbs.)	C (lbs.)	D (lbs.)	29 ft. Jib for All Boom Lengths	See Warning Note: 4	52 ft. Jib for All Boom Lengths	See Warning Note: 4							
	29 ft.	41 ft.	53 ft.	65 ft.	77 ft.											
5	80	44,000														
8	74	29,600														
10	69	24,870	76	22,000						10						
12	65	21,510	73	20,160	78	16,490				12						
14	60	18,960	70	17,710	75	14,390	79	13,860		14						
17	53	16,080	66	15,010	72	12,070	76	11,580	79	11,500						
20	45	13,830	61	13,010	69	10,390	73	9,930	77	9,560						
25	27	10,490	52	10,600	63	8,410	69	8,000	73	7,670	25	79	4,820			
30			42	8,770	56	7,010	64	6,660	69	6,350	30	77	4,270	80	3,000	
35			30	7,120	49	5,930	59	5,650	65	5,390	35	74	3,790	78	2,900	
40					41	5,030	53	4,860	61	4,640	40	71	3,330	76	2,640	
45					31	4,170	47	4,210	56	4,030	45	68	2,900	74	2,410	
50					17	3,070	40	3,630	51	3,530	50	65	2,540	71	2,200	
55								33	3,070	46	3,080	55	62	2,220	69	2,020
60								22	2,410	40	2,680	60	59	1,940	67	1,840
65										34	2,280	65	55	1,660	64	1,670
70										25	1,840	70	51	1,400	61	1,510
75										13	1,220	75	47	1,170	58	1,350
80												80	43	960	55	1,200
85												85	39	760	52	1,060
90												90	34	560	49	940
95															46	790
100															43	650
105															39	510
110																
115																
		680 lbs.		480 lbs.		370 lbs.		300 lbs.		260 lbs.		Deductions for Stowed Jib				

- NOTES:**
- Loads based on crane on outriggers
  - All loads are based on 85% tipping
  - Loads above heavy line are based on structural rating
  - Loads below heavy line are based on tipping rating

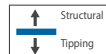

Data published herein is intended as a guide only. Crane operation is subject to machine specific load charts and information.



AVAILABLE AT:  
**GIUFFRE.COM**

**GIUFFRE BROS CRANES INC.**

## 2277S BOOM DIAGRAM

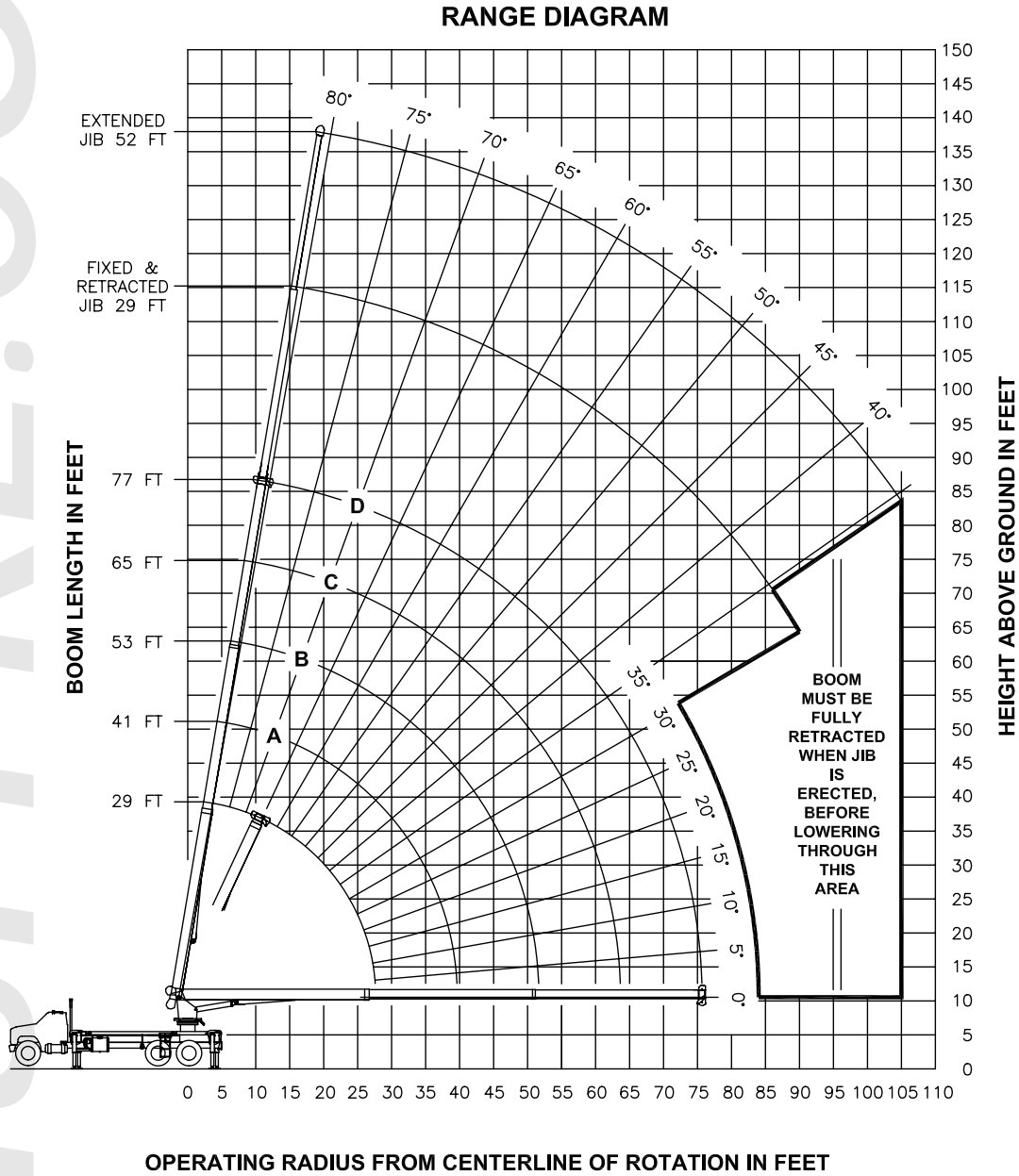

Data published herein is intended as a guide only. Crane operation is subject to machine specific load charts and information.

TC220 SERIES TELESCOPIC CRANE

## AREA OF OPERATION

In order to take advantage of full 360° rotation, the optional front bumper stabilizer must be set in accordance to the manual before working in this area and machine must be level.

If a front bumper stabilizer was not supplied, then the front tires must be in contact with the ground before working in this area.

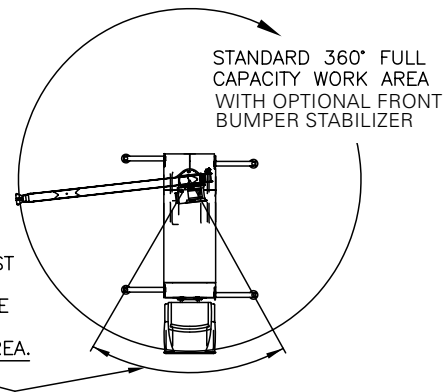

**WARNING:**  
THE FRONT TIRES MUST BE IN CONTACT WITH THE GROUND, AND THE MACHINE LEVEL, WHEN OPERATING IN THIS AREA.

### Deductions from rated loads for load handling devices supplied by Manitex

Auxiliary block	50 lbs. (22.7 kg)
Overhaul ball	See overhaul ball mfg. nameplate
Load blocks	See load block mfg. nameplate
Hose reel	160 lbs. (72.6 kg)
Swing around jib (stowed)	See load chart

**WARNING:** Lifting off the main boom point while the jib is erected is not intended nor approved.

## REEVING DIAGRAM

ALLOWABLE LINE PULL						<b>WARNING</b>
1 PART LINE	2 PART LINE	3 PART LINE	4 PART LINE	5 PART LINE	6 PART LINE	
						<p>ANTI-TWO-BLOCK SYSTEM MUST BE IN GOOD OPERATING CONDITION BEFORE OPERATING CRANE. REFER TO OWNER'S MANUAL.</p> <p>KEEP AT LEAST 3 WRAPS OF LOAD LINE ON DRUM AT ALL TIMES.</p>
8500 LBS	17000 LBS	25500 LBS	34000 LBS	42500 LBS	44000 LBS	
7400 LBS	14800 LBS	22200 LBS	29600 LBS	37000 LBS	44000 LBS	<p>9/16" - 6X25 IWRC (3.5:1 S.F.) 29750 LBS. BREAKING STRENGTH</p> <p>9/16" ROT RESISTANT (5.0:1 S.F.) 37000 LBS. BREAKING STRENGTH</p>

Data published herein is intended as a guide only. Crane operation is subject to machine specific load charts and information.

## LMI OPERATING CODES

Code	Crane Configuration	Outrigger Configuration	Area of Operation
#1	Main Boom	Fully Extended	Full 360°
#2	Fixed Jib	Fully Extended	Full 360
#5	Personnel lifting platform on main boom	Fully Extended	Full 360°
#6	Personnel lifting platform on fixed jib	Fully Extended	Full 360°
#9	Main Boom	Mid Extension	Full 360°
#10	Fixed Jib	Mid Extension	Full 360°
#13	Main Boom	Fully Retracted	Full 360°

### Warning

1. The operator must read and understand the owner's manual before operating the crane.
2. Positioning or operation of crane beyond areas shown on these charts is not intended or approved except where specified in owner's manual.
3. Loaded boom angles at specified boom lengths give only an approximation of the operating radius. The boom angle before loading should be greater to account for deflections. Do not exceed the operating radius for rated loads.
4. The operating radius shown in the jib rating chart is for fully extended boom only. When boom is not fully extended, use only loaded boom angle to determine load rating of jib.
5. For boom angles not shown on jib load rating chart, use rating of next lower boom angle.
6. For boom lengths not shown, use rating of next shorter or longer boom length, whichever is less. For radii not shown, use rating of next longer radius.
7. Crane load ratings on outriggers are based on freely suspended loads with the machine leveled and standing on a firm uniform supporting surface. No attempt shall be made to move a load horizontally on the ground in any direction.
8. Practical working loads depend on supporting surface, wind, and other factors affecting stability such as hazardous surroundings, experience of personnel, and proper handling, all of which must be taken into account by the operator.
9. The maximum load which may be telescoped is limited by hydraulic pressure, boom angle, and boom lubrication. It is safe to attempt to telescope any load within the limits of the load rating chart. Boom must be fully retracted against boom stops at all times when lifting minimum boom length capacity loads.
10. Lifting off the main boom point while the swing around jib is erected is not intended or approved.

### Information

1. Deductions must be made from rated loads for stowed jib, optional attachments, hooks, and load blocks (See deduction chart on page 8). Weights of slings and all other load handling devices shall be considered a part of the load.
2. Load ratings above the blue line are structurally limited capacities. Load ratings below the blue line are stability limited capacities and do not exceed 85% of tipping.

### Definitions

1. Operating radius is the horizontal distance from the axis of rotation to the center of the vertical hoist line or tackle with load applied.
2. Loaded boom angle as shown in the column head by  $\angle$  is the included angle between the horizontal and longitudinal axes of the boom base after lifting rated load at rated radius.

TC220 SERIES TELESCOPIC CRANE

## TECHNICAL DESCRIPTIONS

### Boom



Boom lengths: Proportional boom

- 3-section 77 ft. (23,5 m)
- 4-section 101 ft. (30,8 m)
- 3-Sheave quick reeve boom point
- 1-Idler, 2-Load

Self lubricating slider pad



Max. tip height 2277S: 86' -4" (26,3 m)  
Max. tip height 22101S: 110'5" (33,7 m)



Boom angle (min/max): -6° / 80°

### Rotation



Ball-bearing swing circle with external gear  
Double-reduction planetary gearbox driven by hydraulic motor



Slewing brake: Spring-applied pressure released automatic brake



Slewing speed: 1.5 - 2 rpm. (nominal)  
Boom rotation: 360° continuous

### Outriggers



Outriggers: Out-and-down style  
FBS - Front Bumper Stabilizer (optional)  
Outrigger monitoring system (for verification only)  
Outrigger motion alarm  
Full extension
 

- Center to center: 19'-9 3/4" (6 m)

 Full retraction
 

- Center to center: 7'-4" (2,2 m)

### Operator aids



- 22101S is Radio LMI with crane function cut-offs for overload protection and Radio anti-two block system
- 2277S is Externally Wired LMI with crane function cut-offs for overload protection
- 22101S is Radio anti-two block system

### Hoist, Rope and Hook



Maximum theoretical line speed:  
300 fpm (91 mpm)



Maximum theoretical bottom-layer line pull:  
11,500 lb (5,216 kg)

Rating: Permissible 8,500 lbs (3,855 kg)



Main winch cable diameter: 9/16" (14,3 mm).  
6 x 25 EIPS IWRC Wire Rope

Optional Rotation Resistant Rope 9/16 in.



Line length: 300 ft. (91,4m)



Main winch: Gear Motor with burst of speed high spurt (activated electrically)



Overhaul ball: 5T (4.5 mt) capacity hook with heavy-duty swivel and weight is provided for single line operation.

### Hydraulics



8-bolt direct mounted PTO and SAEB or SAE BB output (factory mounted units only)  
3 -section gear pump, Counter Clockwise Standard, SAE BB input (standard).  
Hydraulic reservoir capacity:  
70 gal. (265 L)  
Pump sections @ 2000 rpm with 100 psi
 

- 32.4 GPM (123 LPM)
- 20.6 GPM (78 LPM)
- 8 GPM (38 LPM)

### Ride Around Operator Station Controls









Standard features:  
Ride-around Operator Station with Open Seat.



Controls:
 

- DS85 –Hirschman display unit
- Four Single axis pilot oil control joy sticks
- Outrigger controls located at rear of truck

## OPTIONS

Boom		Hydraulics	
<b>Max. Tip Height</b>  <p>2277S</p> <ul style="list-style-type: none"> <li>• Max. tip height: 86'-4" (26,3m)</li> </ul> <p>22101S</p> <ul style="list-style-type: none"> <li>• Max tip height: 110.5 ft (33,7 m)</li> </ul>		 <p>Hose reel – boom mounted. Front Bumper Stabilizer (FBS) Hydraulic oil cooler</p>	
<b>Jibs</b> <p>2277S, 22101S</p> <ul style="list-style-type: none"> <li>• 1-section fixed jib: 30.5 ft. (9,3 m)</li> <li>• 2-Section telescopic jib 29'-52' (8,8 m - 15,8 m) for 77' boom only</li> </ul>		<b>Cab</b>  <p>Optional Cab available</p> <ul style="list-style-type: none"> <li>• Air Conditioner</li> <li>• Heater</li> </ul>	
<b>Max. Tip Height with Extension</b>  <p>2277S</p> <ul style="list-style-type: none"> <li>• Max tip height with extension: 138'-3" (42,1 m)</li> <li>• Max tip height with extension retracted: 115' - 6" (35,2 m)</li> </ul> <p>22101S</p> <ul style="list-style-type: none"> <li>• Max. tip height with extension: 139'-7" (42,5 m)</li> </ul>		<b>2-person Basket</b>  <p>Consult Manitex for specific application and rating</p> <ul style="list-style-type: none"> <li>• 2-person Steel Gravity Levelled Basket with Friction Brake</li> <li>• 2-person Steel Gravity Levelled Basket with Hydraulic Brake and Manual Rotation</li> </ul>	
<b>Bulkhead</b> <p>24 in. (607 mm) bulkhead</p>		<b>Tool Boxes &amp; Flatbed</b> <p>Tool Boxes</p> <ul style="list-style-type: none"> <li>• 24 in. L x 18 in. W x 18 in. H (610 mm L x 457 mm W x 457 mm H)</li> <li>• 48 in. L x 24 in. W x 24 in. H (1,219 mm L x 610 mm W x 610 mm H)</li> </ul> <p>Flatbeds</p> <ul style="list-style-type: none"> <li>• 13' (4 m) Steel Flatbed</li> <li>• 13' (4 m) Wood Flatbed</li> </ul>	
<b>Hook Block</b>  <p>Auxiliary lower sheave block for 2-8 part lines Load blocks 1-3, 1-6, 2-6 part lines</p>			

To learn more about this model, call 414-764-9200 or visit [giuffre.com](http://giuffre.com) today!

**Manitex**



# TC220

**22-Ton (20 mt) TELESCOPIC CRANE**  
TC220 SERIES PRODUCT GUIDE

**UPTIME**

UPTIME is the Manitex commitment to complete support of thousands of units working every day.

**MANITEX**  
3000 South Austin Avenue  
Georgetown, Texas 78626  
**1-877-314-3390** [www.Manitex.com](http://www.Manitex.com)

Manitex reserves the right that specification, equipment and prices are all subject to change without notice or obligation.

MTX-TC200-PC-EN-V2-0815



AVAILABLE AT:

**GIUFFRE.COM**

**GIUFFRE BROS CRANES INC.**

6635 SOUTH 13TH ST. - MILWAUKEE, WI 53221  
414-764-9200 • 877-321-3710



To learn more about this model, call 414-764-9200 or visit [giuffre.com](http://giuffre.com) today!

GIUFFRE.COM

# Load Rating Chart

**Model 22101S**



© Manitex 2000

**NOTE:** Additional copies of this Load Rating Chart can be purchased from your Manitex Distributor. When ordering, use the part number shown in the bottom left corner of this page.

7300092-002 NR



AVAILABLE AT:

**GIUFFRE.COM**

**GIUFFRE BROS CRANES INC.**

6635 SOUTH 13TH ST. - MILWAUKEE, WI 53221  
414-764-9200 • 877-321-3710

To learn more about this model, call 414-764-9200 or visit [giuffre.com](http://giuffre.com) today!

**RANGE DIAGRAM  
- FULLY EXTENDED OUTRIGGER CONFIGURATION -**

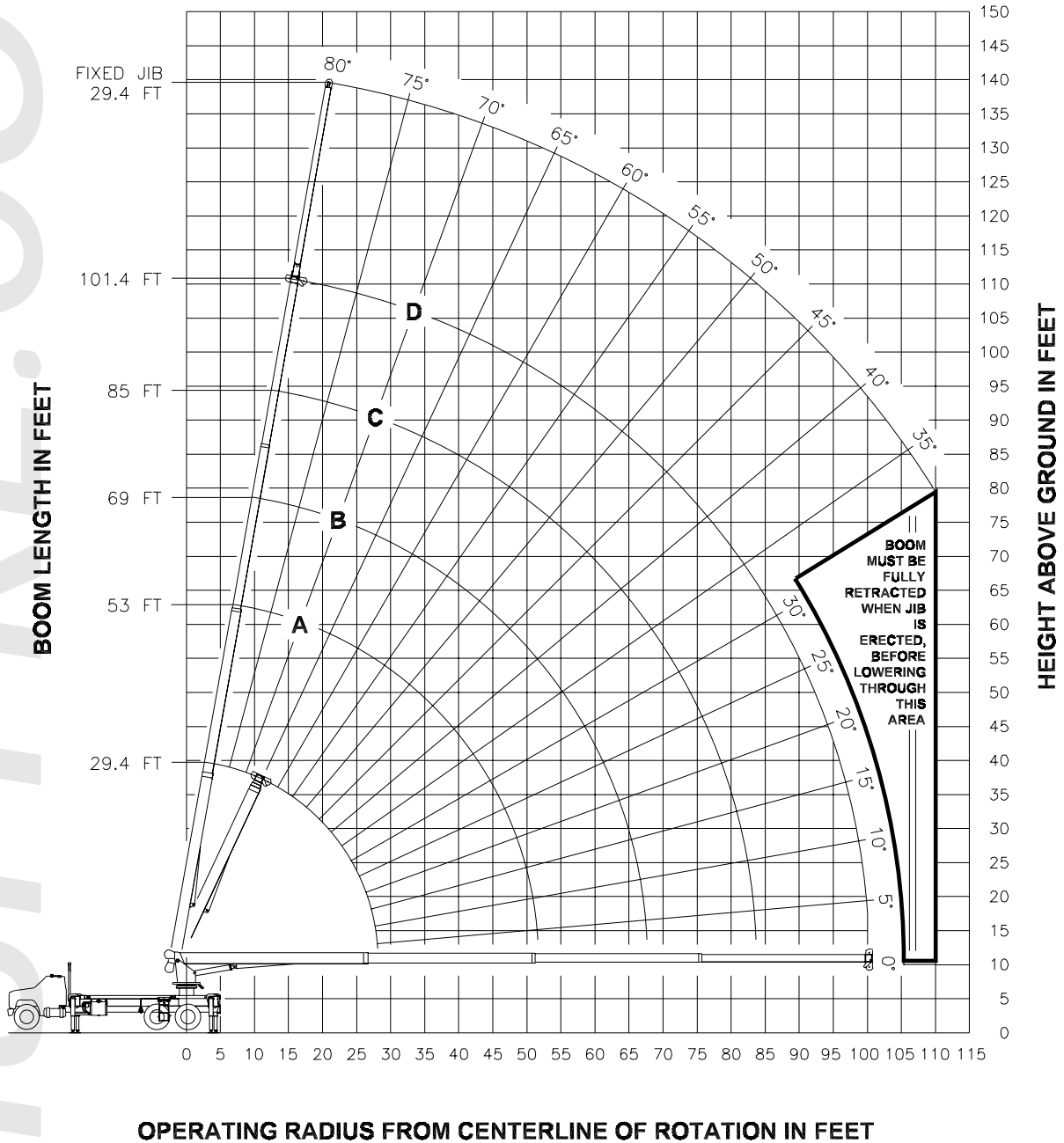

7300092-002 NR



AVAILABLE AT:

**GIUFFRE.COM**

GIUFFRE BROS CRANES INC.

6635 SOUTH 13TH ST. - MILWAUKEE, WI 53221  
414-764-9200 • 877-321-3710

To learn more about this model, call 414-764-9200 or visit [giuffre.com](http://giuffre.com) today!

**USE THIS CHART ONLY  
WHEN ALL  
OUTRIGGERS ARE  
FULLY EXTENDED**

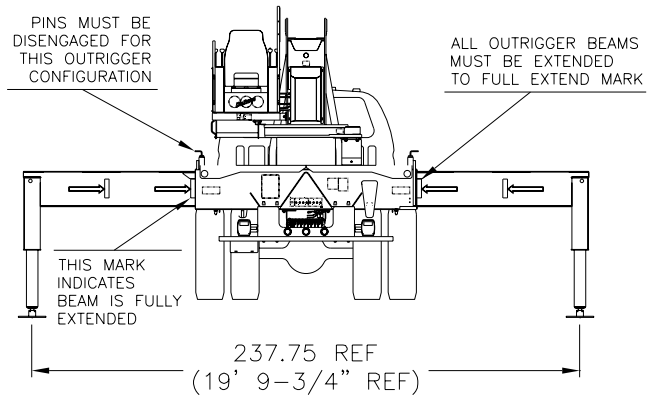

**- FULLY EXTENDED OUTRIGGER CONFIGURATION -**

MAIN BOOM LOAD RATINGS IN LBS										JIB LOAD RATINGS IN LBS				
O P E R A T I O N S	LMI CODE #1									LMI CODE #2				
	LOADED BOOM ANGLE		BOOM LENGTH AND MARKER							O P E R A T I O N S	B O O M L O A D I N G	29.4 FT JIB FOR ALL BOOM LENGTHS SEE WARNING NOTE 4		
	°	29.4 FT	°	A	°	B	°	C	°				D	°
5	80	44000												
8	74	33540										8		
10	70	28140										10		
12	66	24230	78	14000								12		
14	61	20460	76	14000	80	14000						14		
17	54	16400	72	14000	78	12880						17		
20	46	13520	69	13700	75	11430	79	8920				20		
25	29	10210	63	10600	71	9460	75	8000	79	6000		25		
30			56	8390	66	8210	72	7070	76	5500	30	80	3000	
35			49	6790	61	6890	68	6130	73	4980	35	78	2840	
40			41	5590	56	5700	65	5320	70	4490	40	76	2620	
45			31	4640	51	4760	61	4640	67	4000	45	73	2420	
50			17	3880	45	4000	57	4070	64	3580	50	71	2230	
55					38	3380	52	3450	61	3200	55	69	2020	
60					30	2860	47	2930	57	2850	60	67	1840	
65					19	2410	42	2490	54	2520	65	64	1670	
70							36	2090	50	2130	70	62	1520	
75							29	1740	45	1790	75	59	1380	
80							20	1440	41	1500	80	56	1230	
85									36	1240	85	53	1080	
90									30	1020	90	50	950	
95									22	820	95	47	830	
100											100	44	720	
105											105	40	570	
110											110	36	430	
		340 LBS.		190 LBS.		150 LBS.		120 LBS.		100 LBS.		DEDUCTIONS FOR STOWED JIB		

7300092-002 NR



AVAILABLE AT:

**GIUFFRE.COM**

GIUFFRE BROS CRANES INC.

6635 SOUTH 13TH ST. - MILWAUKEE, WI 53221  
414-764-9200 • 877-321-3710

To learn more about this model, call 414-764-9200 or visit [giuffre.com](http://giuffre.com) today!

**RANGE DIAGRAM  
- INTERMEDIATE OUTRIGGER CONFIGURATION -  
(MID EXTEND)**

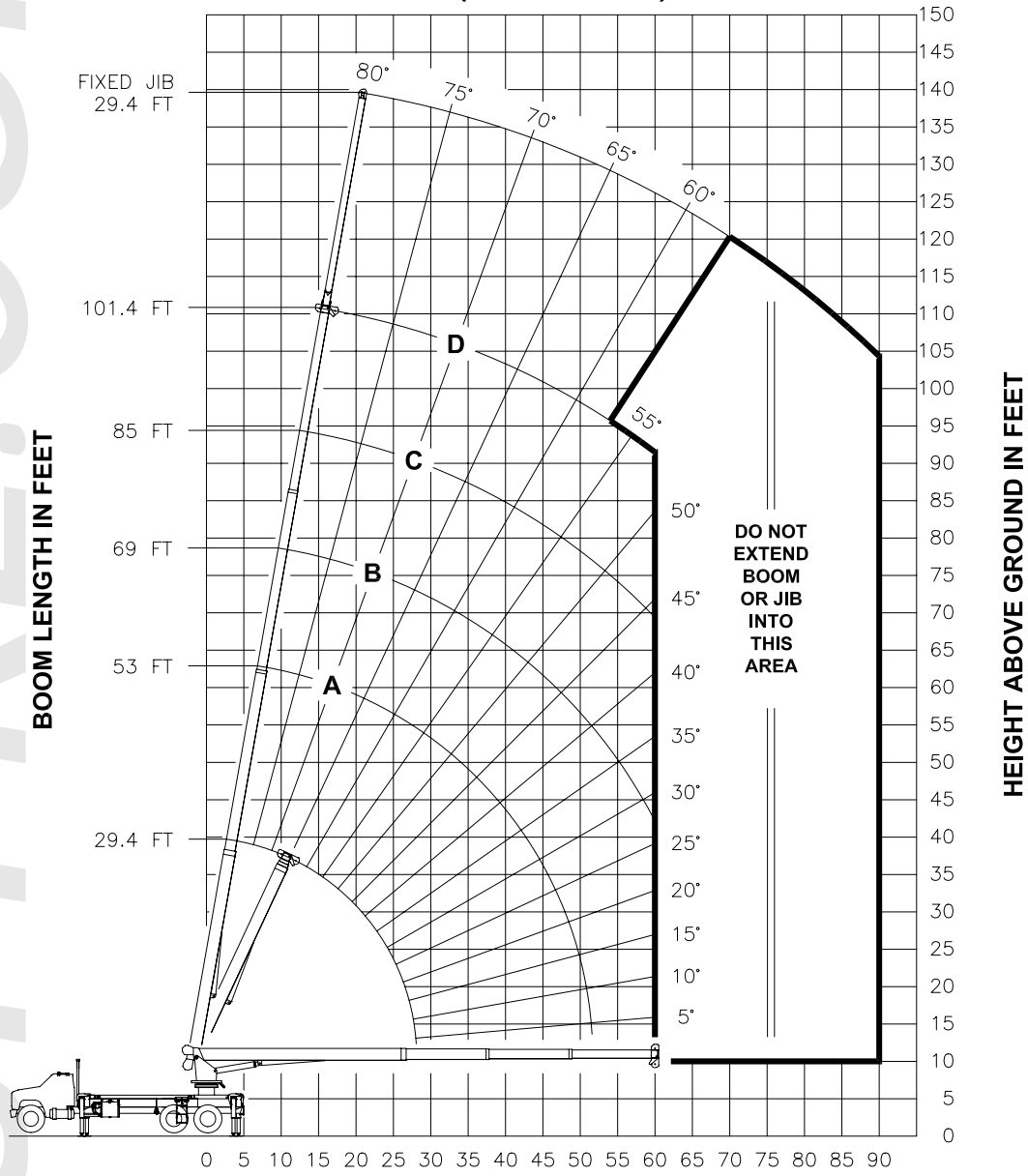

**OPERATING RADIUS FROM CENTERLINE OF ROTATION IN FEET**

**NOTE :** LIFTING PERSONNEL WITH CRANE IN THIS OUTRIGGER CONFIGURATION IS STRICTLY PROHIBITED. USE ONLY FULLY EXTENDED OUTRIGGER CONFIGURATION WHEN LIFTING PERSONNEL.

7300092-002 NR



AVAILABLE AT:

**GIUFFRE.COM**

GIUFFRE BROS CRANES INC.

6635 SOUTH 13TH ST. - MILWAUKEE, WI 53221  
414-764-9200 • 877-321-3710

To learn more about this model, call 414-764-9200 or visit [giuffre.com](http://giuffre.com) today!

**USE THIS CHART ONLY  
WHEN ALL  
OUTRIGGERS ARE IN  
THE INTERMEDIATE  
POSITION**

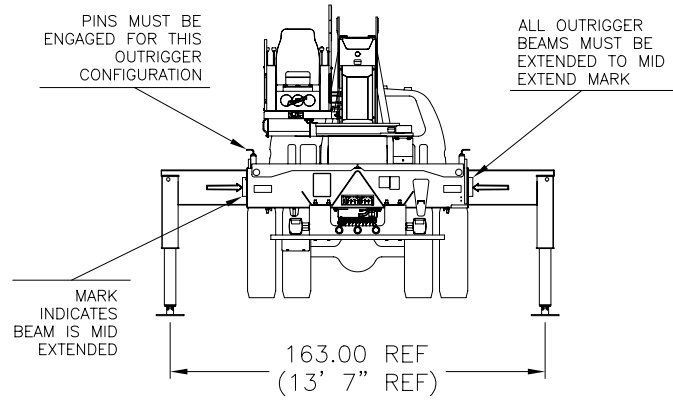

**- INTERMEDIATE OUTRIGGER CONFIGURATION -  
(MID EXTEND)**

MAIN BOOM LOAD RATINGS IN LBS											JIB LOAD RATINGS IN LBS					
LMI CODE #9											LMI CODE #10					
OPERATING HEIGHT	LOADED BOOM ANGLE		BOOM LENGTH AND MARKER								OPERATING HEIGHT	BOOM LOADING ANGLE	29.4 FT JIB FOR ALL BOOM LENGTHS  SEE WARNING NOTE 4			
	29.4 FT	53 FT	69 FT	85 FT	101.4 FT	A	B	C	D	RATED LOAD IN POUNDS						
5	80	44000														
8	74	33540											8			
10	70	28140											10			
12	66	24230	78	14000									12			
14	61	20460	76	14000	80	14000							14			
17	54	14040	72	14000	78	12880							17			
20	46	10190	69	10690	75	10820	79	8920					20			
25	29	6560	63	7050	71	7170	75	7240	79	6000			25			
30			56	4970	66	5090	72	5160	76	5210	30	80	3000			
35			49	3630	61	3750	68	3810	73	3860	35	78	2840			
40			41	2690	56	2810	65	2870	70	2910	40	76	2620			
45			31	1990	51	2110	61	2180	67	2220	45	73	2310			
50			17	1450	45	1570	57	1640	64	1680	50	71	1770			
55					38	1150	52	1220	61	1260	55	69	1350			
60					30	800	47	870	57	910	60	67	1000			
65											65	64	710			
70											70	62	470			
		340 LBS.	190 LBS.	150 LBS.	120 LBS.	100 LBS.	DEDUCTIONS FOR STOWED JIB									

7300092-002 NR



AVAILABLE AT:

**GIUFFRE.COM**

GIUFFRE BROS CRANES INC.

6635 SOUTH 13TH ST. - MILWAUKEE, WI 53221  
414-764-9200 • 877-321-3710

To learn more about this model, call 414-764-9200 or visit [giuffre.com](http://giuffre.com) today!

GIUFFRE.COM

**RANGE DIAGRAM  
- FULLY RETRACTED OUTRIGGER CONFIGURATION -**

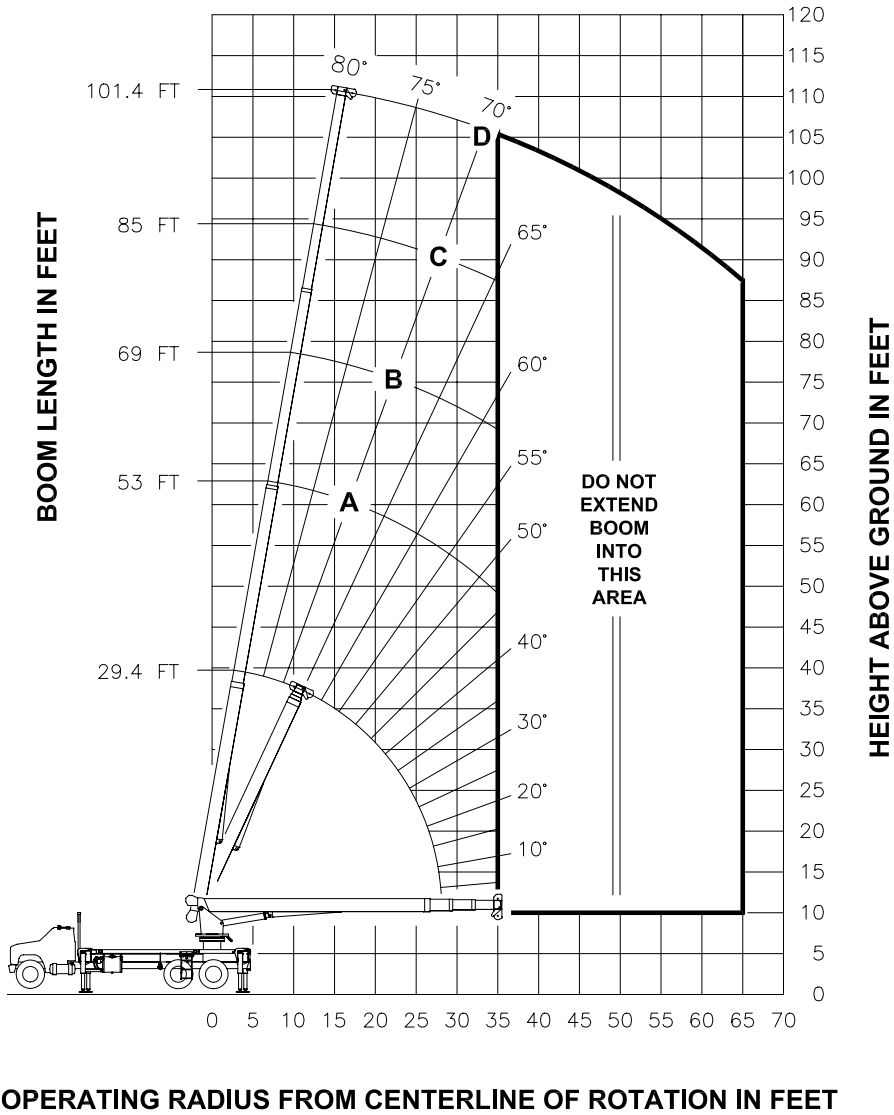

**NOTE :** LIFTING PERSONNEL WITH CRANE IN THIS OUTRIGGER CONFIGURATION IS STRICTLY PROHIBITED. USE ONLY FULLY EXTENDED OUTRIGGER CONFIGURATION WHEN LIFTING PERSONNEL.

7300092-002 NR



AVAILABLE AT:

**GIUFFRE.COM**

GIUFFRE BROS CRANES INC.

6635 SOUTH 13TH ST. - MILWAUKEE, WI 53221  
414-764-9200 • 877-321-3710

To learn more about this model, call 414-764-9200 or visit [giuffre.com](http://giuffre.com) today!

**USE THIS CHART  
ONLY WHEN ALL  
OUTRIGGERS ARE  
FULLY RETRACTED**

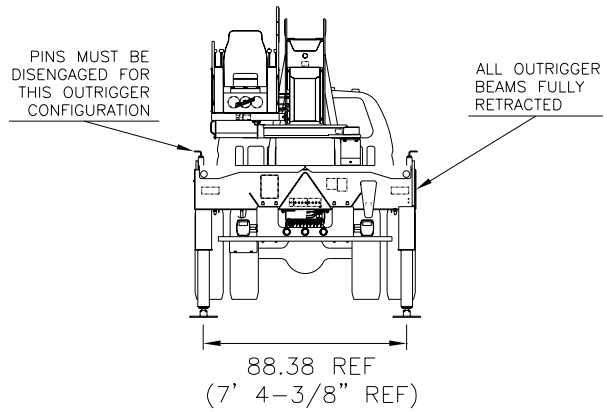

**- FULLY RETRACTED OUTRIGGER CONFIGURATION -**

MAIN BOOM LOAD RATINGS IN LBS															
LMI CODE #13															
OPERATING RADIUS IN FT	LOADED BOOM ANGLE		BOOM LENGTH AND MARKER												
	29.4 FT	30.0 FT	53 FT	54.0 FT	A	B	C	D	101.4 FT						
5	80	44000													
8	74	19630													
10	70	12510													
12	66	8810	78	9270											
14	61	6540	76	6970	80	7090									
17	54	4420	72	4830	78	4940									
20	46	3060	69	3470	75	3580	79	3640							
25	29	1640	63	2050	71	2160	75	2220	79	2260					
30			56	1170	66	1270	72	1330	76	1370					
35					61	670	68	730	73	770					
		340 LBS.			190 LBS.			150 LBS.			120 LBS.			100 LBS.	DEDUCTIONS FOR STOWED JIB

**NO JIBS ARE TO  
BE ERECTED IN  
THIS  
OUTRIGGER  
CONFIGURATION**

7300092-002 NR



AVAILABLE AT:

**GIUFFRE.COM**

GIUFFRE BROS CRANES INC.

6635 SOUTH 13TH ST. - MILWAUKEE, WI 53221  
414-764-9200 • 877-321-3710

To learn more about this model, call 414-764-9200 or visit [giuffre.com](http://giuffre.com) today!

ALLOWABLE LINE PULL						<h2>WARNING</h2> <p>ANTI-TWO-BLOCK SYSTEM MUST BE IN GOOD OPERATING CONDITION BEFORE OPERATING CRANE. REFER TO OWNER'S MANUAL.</p> <p>KEEP AT LEAST 3 WRAPS OF LOAD LINE ON DRUM AT ALL TIMES.</p>
1 PART LINE	2 PART LINE	3 PART LINE	4 PART LINE	5 PART LINE	6 PART LINE	
<p>OVERHAUL BALL</p>	<p>SINGLE OR TRIPLE SHEAVE LOAD BLOCK</p>	<p>SINGLE OR TRIPLE SHEAVE LOAD BLOCK</p>	<p>DOUBLE OR TRIPLE SHEAVE LOAD BLOCK</p>	<p>DOUBLE OR TRIPLE SHEAVE LOAD BLOCK AUXILIARY BLOCK</p>	<p>TRIPLE SHEAVE LOAD BLOCK AUXILIARY BLOCK</p>	
8500 LBS	17000 LBS	25500 LBS	34000 LBS	42500 LBS	44000 LBS	
7400 LBS	14800 LBS	22200 LBS	29600 LBS	37000 LBS	44000 LBS	
						9/16" - 6X25 IWRC (3.5:1 S.F.) 29750 LBS. BREAKING STRENGTH 9/16" ROT RESISTANT (5.0:1 S.F.) 37000 LBS. BREAKING STRENGTH

### AREA OF OPERATION

**WARNING:**  
 THE FRONT TIRES MUST BE IN CONTACT WITH THE GROUND, AND THE MACHINE LEVEL, WHEN OPERATING IN THIS AREA.

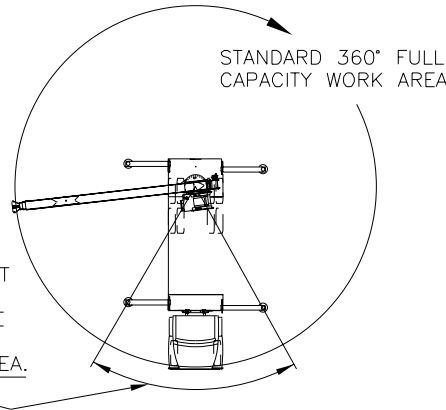

### DEDUCTIONS FROM RATED LOADS FOR LOAD HANDLING DEVICES SUPPLIED BY MANITEX

AUXILIARY BLOCK ————— 50 LBS  
 OVERHAUL BALL ————— SEE OVERHAUL BALL MANUFACTURER NAMEPLATE  
 LOAD BLOCK ————— SEE BLOCK MANUFACTURER NAMEPLATE  
 HOSE REEL ————— 160 LBS  
 SWING AROUND JIB ————— SEE LOAD CHART

7300092-002 NR



AVAILABLE AT:

**GIUFFRE.COM**

GIUFFRE BROS CRANES INC.

6635 SOUTH 13TH ST. - MILWAUKEE, WI 53221  
 414-764-9200 • 877-321-3710



To learn more about this model, call 414-764-9200 or visit [giuffre.com](http://giuffre.com) today!

**LMI OPERATING CODES**

SETTING	CRANE CONFIGURATION	OUTRIGGER CONFIGURATION
#1	— MAIN BOOM	— FULLY EXTENDED
#2	— FIXED JIB	— FULLY EXTENDED
#5	— PERSONNEL LIFTING PLATFORM ON MAIN BOOM	— FULLY EXTENDED
#6	— PERSONNEL LIFTING PLATFORM ON FIXED JIB	— FULLY EXTENDED
#9	— MAIN BOOM	— INTERMEDIATE
#10	— FIXED JIB	— INTERMEDIATE
#13	— MAIN BOOM	— FULLY RETRACTED

**WARNING**

1. THE OPERATOR MUST READ AND UNDERSTAND THE OWNER'S MANUAL BEFORE OPERATING THIS CRANE.
2. POSITIONING OR OPERATION OF CRANE BEYOND AREAS SHOWN ON THIS CHART IS NOT INTENDED OR APPROVED EXCEPT WHERE SPECIFIED IN OWNER'S MANUAL.
3. LOADED BOOM ANGLES AT SPECIFIED BOOM LENGTHS GIVE ONLY AN APPROXIMATION OF THE OPERATING RADIUS. THE BOOM ANGLE BEFORE LOADING SHOULD BE GREATER TO ACCOUNT FOR DEFLECTIONS. DO NOT EXCEED THE OPERATING RADIUS FOR RATED LOADS.
4. THE OPERATING RADIUS SHOWN IN THE JIB RATING CHART IS FOR FULLY EXTENDED BOOM ONLY. WHEN BOOM IS NOT FULLY EXTENDED, USE ONLY LOADED BOOM ANGLE TO DETERMINE LOAD RATING OF JIB.
5. FOR BOOM ANGLES NOT SHOWN ON JIB LOAD RATING CHART, USE RATING OF NEXT LOWER BOOM ANGLE.
6. FOR BOOM LENGTHS NOT SHOWN, USE RATING OF NEXT SHORTER OR LONGER BOOM LENGTH, WHICHEVER IS LESS. FOR RADII NOT SHOWN, USE RATING OF NEXT LONGER RADIUS.
7. CRANE LOAD RATINGS ON OUTRIGGERS ARE BASED ON FREELY SUSPENDED LOADS WITH THE MACHINE LEVELED AND STANDING ON A FIRM UNIFORM SUPPORTING SURFACE. NO ATTEMPT SHALL BE MADE TO MOVE A LOAD HORIZONTALLY ON THE GROUND IN ANY DIRECTION.

7300092-002 NR



AVAILABLE AT:

**GIUFFRE.COM**

**GIUFFRE BROS CRANES INC.**

6635 SOUTH 13TH ST. - MILWAUKEE, WI 53221  
414-764-9200 • 877-321-3710

**WARNING (CONTINUED)**

8. PRACTICAL WORKING LOADS DEPEND ON SUPPORTING SURFACE, WIND, AND OTHER FACTORS AFFECTING STABILITY SUCH AS HAZARDOUS SURROUNDINGS, EXPERIENCE OF PERSONNEL, AND PROPER HANDLING, ALL OF WHICH MUST BE TAKEN INTO ACCOUNT BY THE OPERATOR.
9. THE MAXIMUM LOAD WHICH MAY BE TELESCOPED IS LIMITED BY HYDRAULIC PRESSURE, BOOM ANGLE, AND BOOM LUBRICATION. IT IS SAFE TO ATTEMPT TO TELESCOPE ANY LOAD WITHIN THE LIMITS OF THE LOAD RATING CHART. BOOM MUST BE FULLY RETRACTED AGAINST BOOM STOPS AT ALL TIMES WHEN LIFTING MINIMUM BOOM LENGTH CAPACITY LOADS.
10. LIFTING OFF THE MAIN BOOM POINT WHILE THE SWING AROUND JIB IS ERECTED IS NOT INTENDED OR APPROVED.

**INFORMATION**

1. DEDUCTIONS MUST BE MADE FROM RATED LOADS FOR STOWED JIB, OPTIONAL ATTACHMENTS, HOOKS, AND LOADBLOCKS (SEE DEDUCTION CHART). WEIGHTS OF SLINGS AND ALL OTHER LOAD HANDLING DEVICES SHALL BE CONSIDERED A PART OF THE LOAD.
2. LOAD RATINGS ABOVE THE HEAVY LINE ARE STRUCTURALLY LIMITED CAPACITIES. LOAD RATINGS BELOW THE HEAVY LINE ARE STABILITY LIMITED CAPACITIES AND DO NOT EXCEED 85% OF TIPPING.

**DEFINITIONS**

1. OPERATING RADIUS IS THE HORIZONTAL DISTANCE FROM THE AXIS OF ROTATION TO THE CENTER OF THE VERTICAL HOIST LINE OR TACKLE WITH LOAD APPLIED.
2. LOADED BOOM ANGLE AS SHOWN IN THE COLUMN HEADED BY  $\angle$ , IS THE INCLUDED ANGLE BETWEEN THE HORIZONTAL AND LONGITUDINAL AXES OF THE BOOM BASE AFTER LIFTING RATED LOAD AT RATED RADIUS.

7300092-002 NR