

PK 65002 SH

PALFINGER

LIFETIME EXCELLENCE

MÁXIMA POTENCIA DE ELEVACIÓN. LA TECNOLOGÍA HPSC PERMITE UTILIZAR LA GRÚA INCLUSO EN CIRCUNSTANCIAS DE ESPACIO LIMITADO.



PK 65002 SH

HIGH PERFORMANCE

B

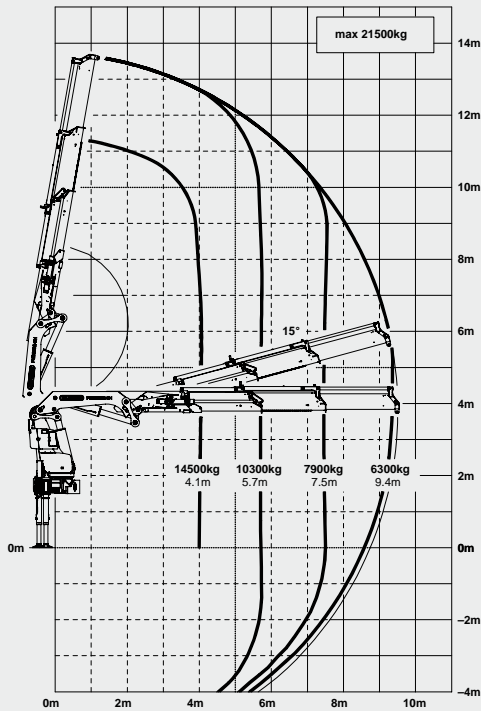

C

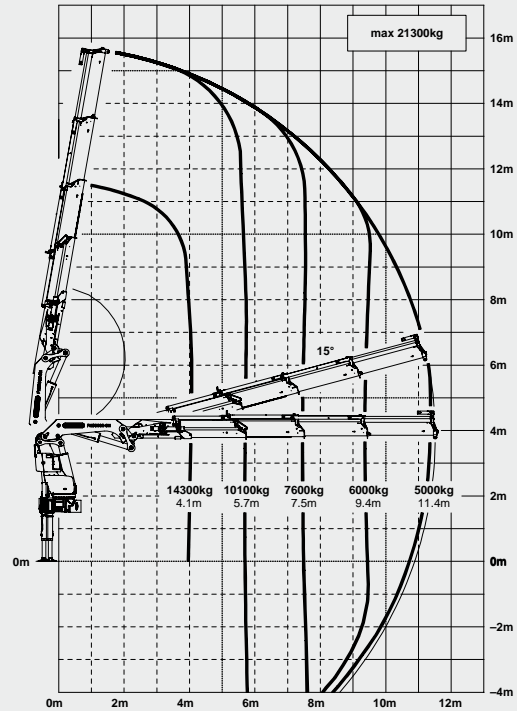

E

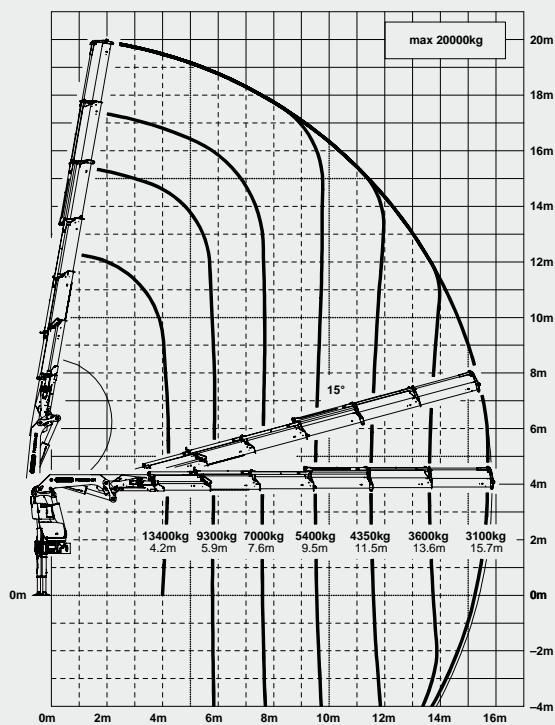

G

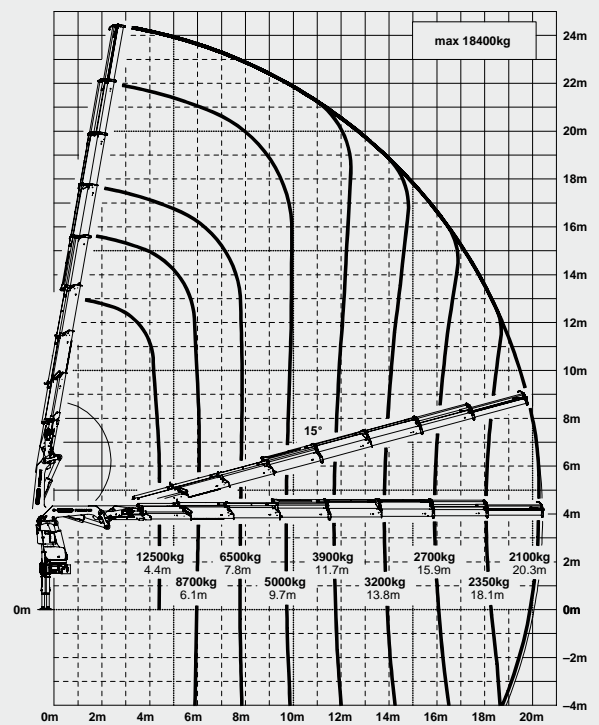

GEOMETRÍA DE MOVIMIENTOS EXCEPCIONAL

D PJ170E JV1 DPS PLUS

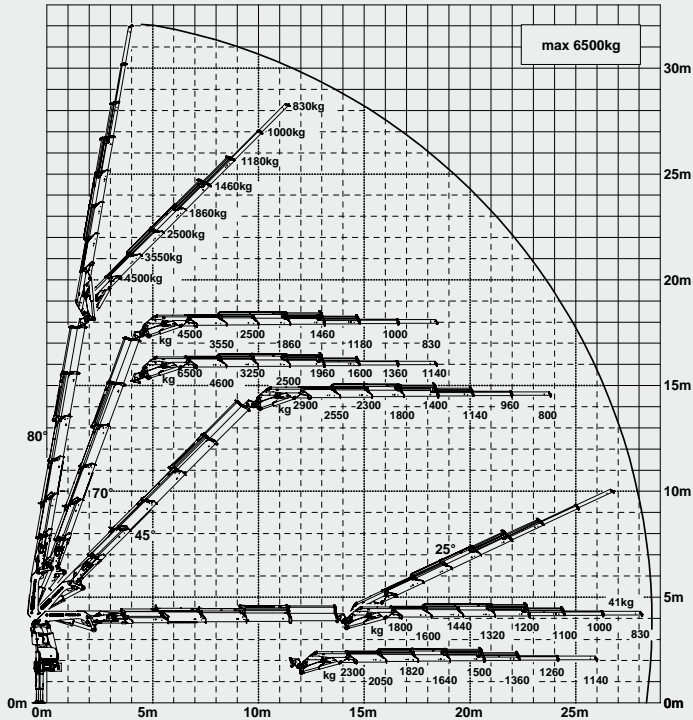

F PJ125E JV1 DPS PLUS

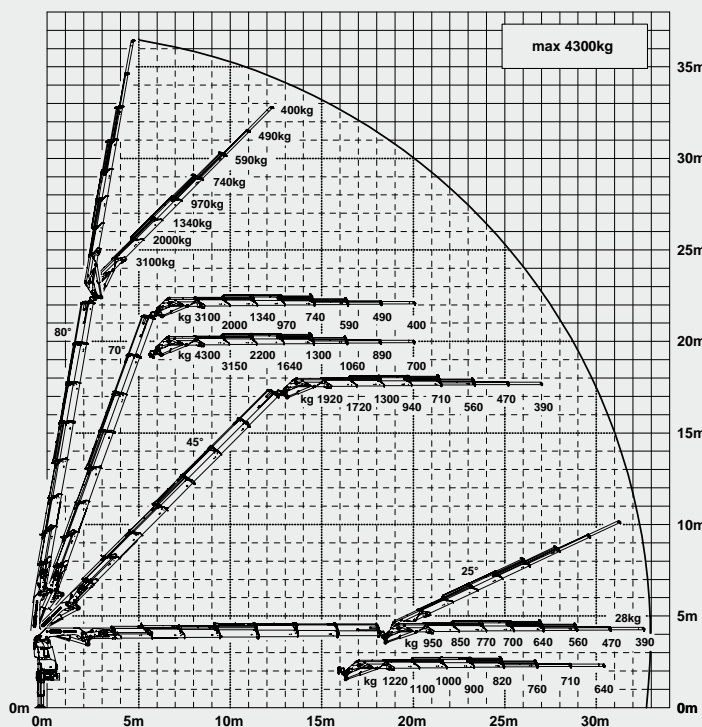

CAPACIDAD

A	max.	21800 kg /213,9 kN
	4,0 m	14800 kg /145,2 kN
	5,7 m	10600 kg /104,0 kN
	7,4 m	8200 kg / 80,4 kN

B	max.	21500 kg /210,9 kN
	4,1 m	14500 kg /142,2 kN
	5,7 m	10300 kg /101,0 kN
	7,5 m	7900 kg / 77,5 kN
	9,4 m	6300 kg / 61,8 kN

C	max.	21300 kg /209,0 kN
	4,1 m	14300 kg /140,3 kN
	5,7 m	10100 kg / 99,1 kN
	7,5 m	7600 kg / 74,6 kN
	9,4 m	6000 kg / 58,9 kN
	11,4 m	5000 kg / 49,1 kN

D	max.	20700 kg /203,1 kN
	4,2 m	13700 kg /134,4 kN
	5,8 m	9600 kg / 94,2 kN
	7,6 m	7300 kg / 71,6 kN
	9,5 m	5700 kg / 55,9 kN
	11,5 m	4650 kg / 45,6 kN
	13,6 m	3900 kg / 38,3 kN

E	max.	20000 kg /196,2 kN
	4,2 m	13400 kg /131,5 kN
	5,9 m	9300 kg / 91,2 kN
	7,6 m	7000 kg / 68,7 kN
	9,5 m	5400 kg / 53,0 kN
	11,5 m	4350 kg / 42,7 kN
	13,6 m	3600 kg / 35,2 kN
	15,7 m	3100 kg / 30,4 kN

F	max.	19100 kg /187,4 kN
	4,3 m	12900 kg /126,5 kN
	6,0 m	9000 kg / 88,3 kN
	7,7 m	6700 kg / 65,7 kN
	9,6 m	5200 kg / 51,0 kN
	11,6 m	4100 kg / 40,2 kN
	13,7 m	3400 kg / 33,4 kN
	15,8 m	2900 kg / 28,4 kN
	18,0 m	2500 kg / 24,5 kN

G	max.	18400 kg /180,5 kN
	4,4 m	12500 kg /122,6 kN
	6,1 m	8700 kg / 85,3 kN
	7,8 m	6500 kg / 63,8 kN
	9,7 m	5000 kg / 49,1 kN
	11,7 m	3900 kg / 38,3 kN
	13,8 m	3200 kg / 31,4 kN
	15,9 m	2700 kg / 26,5 kN
	18,1 m	2350 kg / 23,1 kN
	20,3 m	2100 kg / 20,6 kN
	22,6 m*	1780 kg / 17,5 kN
	24,9 m*	1000 kg / 9,8 kN

*Prolongación mecánica

PERFECTAS DIMENSIONES

VARIANTES DE PROLONGAS

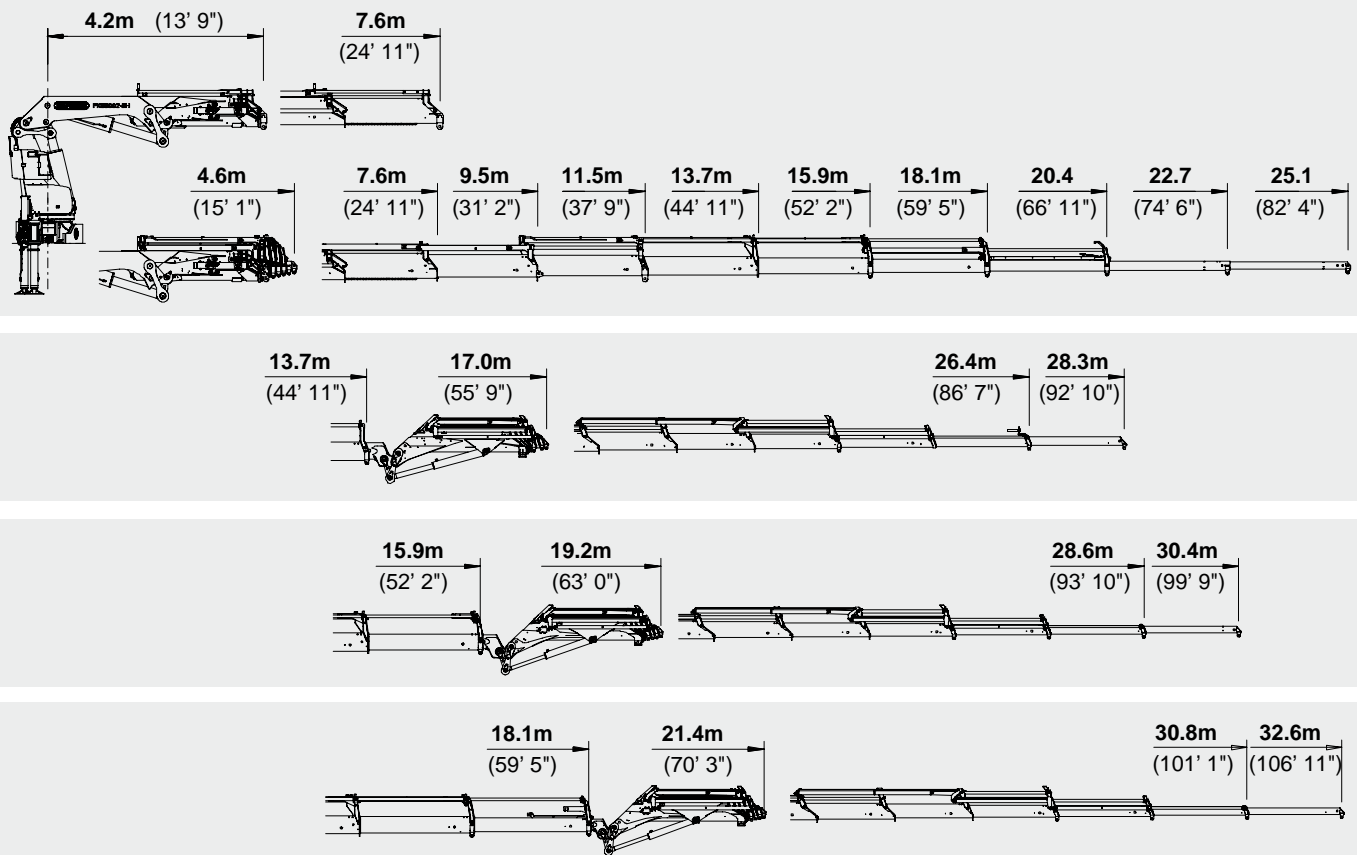

DIMENSIONES

