

# PK 44002

Performance

**PALFINGER CRANE**



LA REVOLUCIÓN EN LA GAMA DE GRÚAS GRANDES



# UNA TECNICA QUE CONVINCE

F

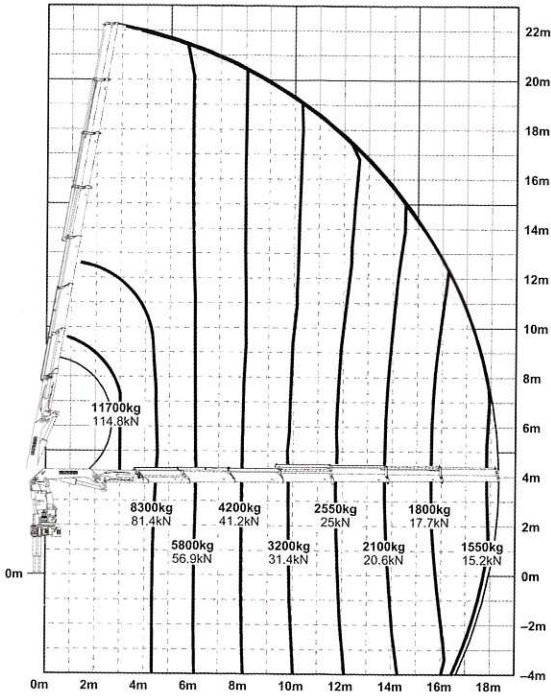

G

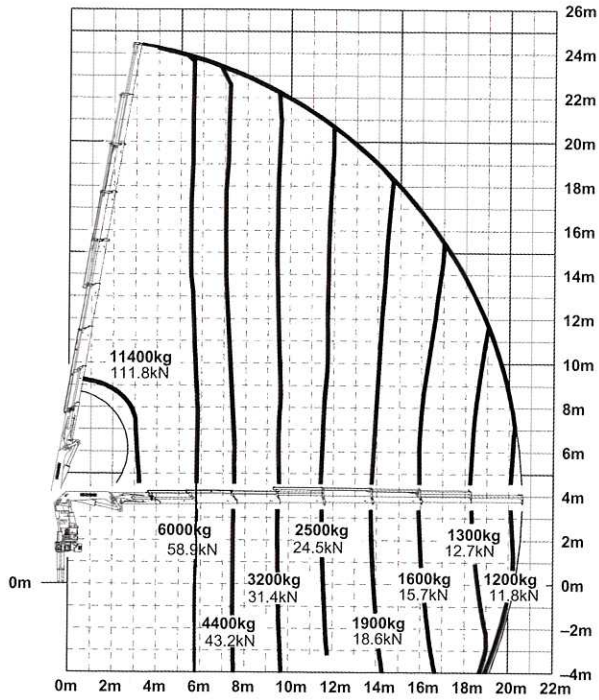

F PJ060B

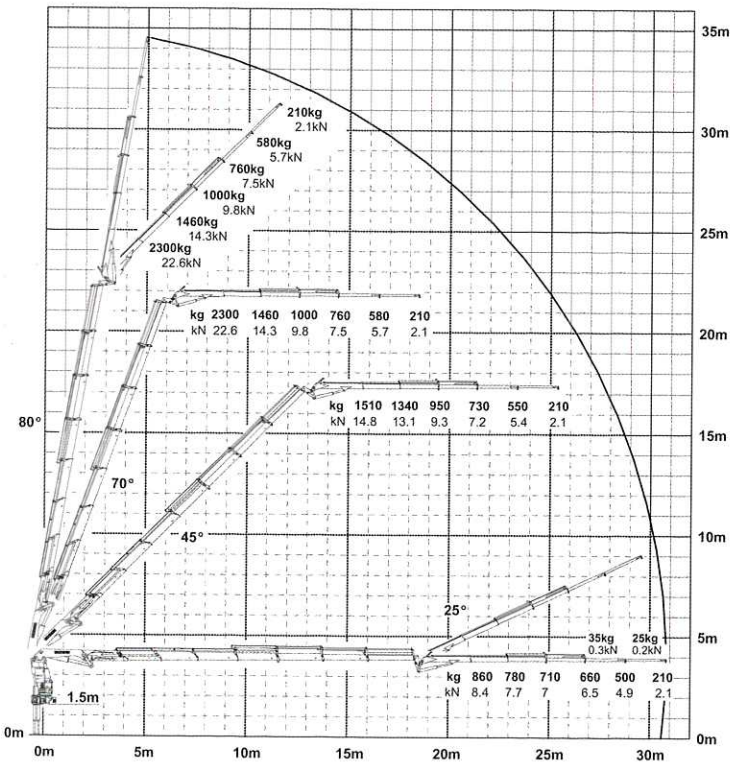

D  
M

# POTENTE Y DE USO POLIFACETICO

D

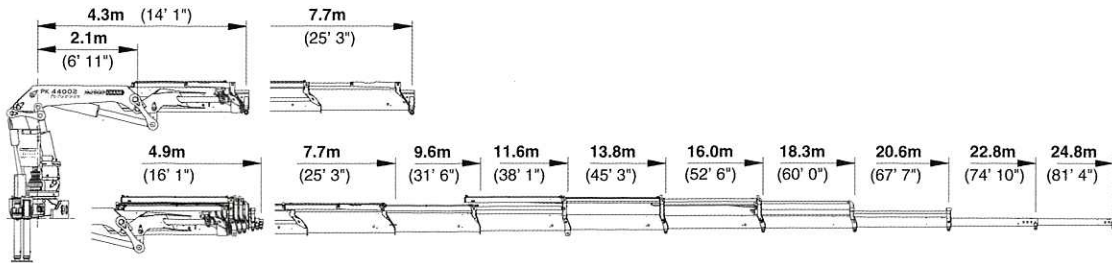

PK 44002D PJ125E

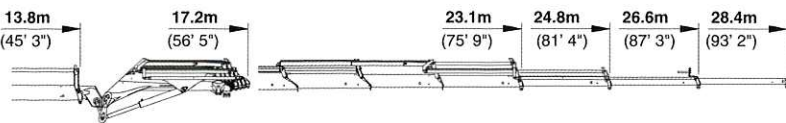

PK 44002E PJ080C

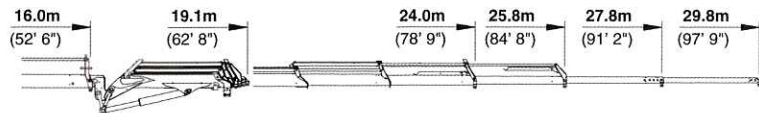

PK 44002F PJ060B

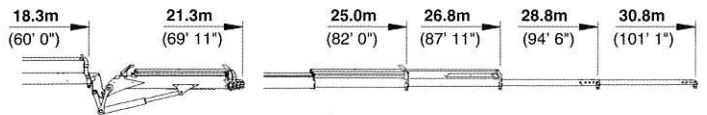

D

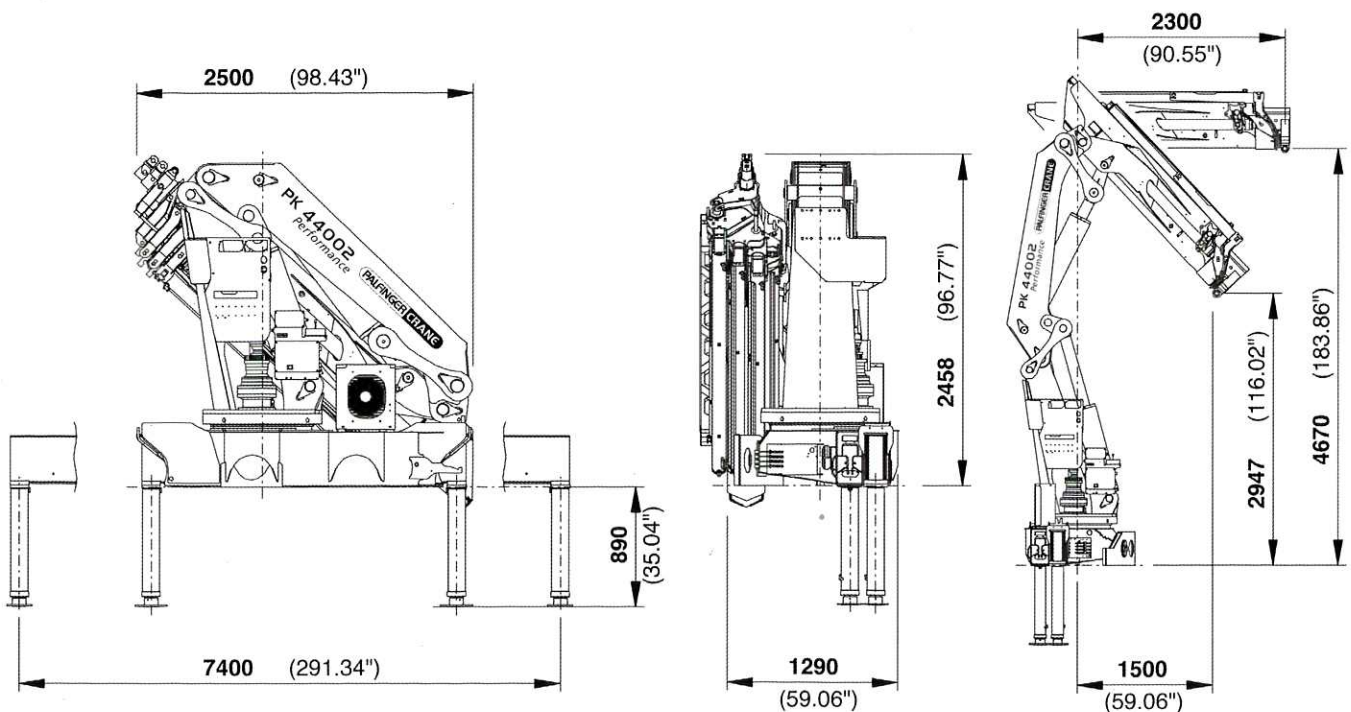

# SERVICIO GARANTIZADO A TRAVÉS DE 1.500 PUNTOS EN TODO EL MUNDO

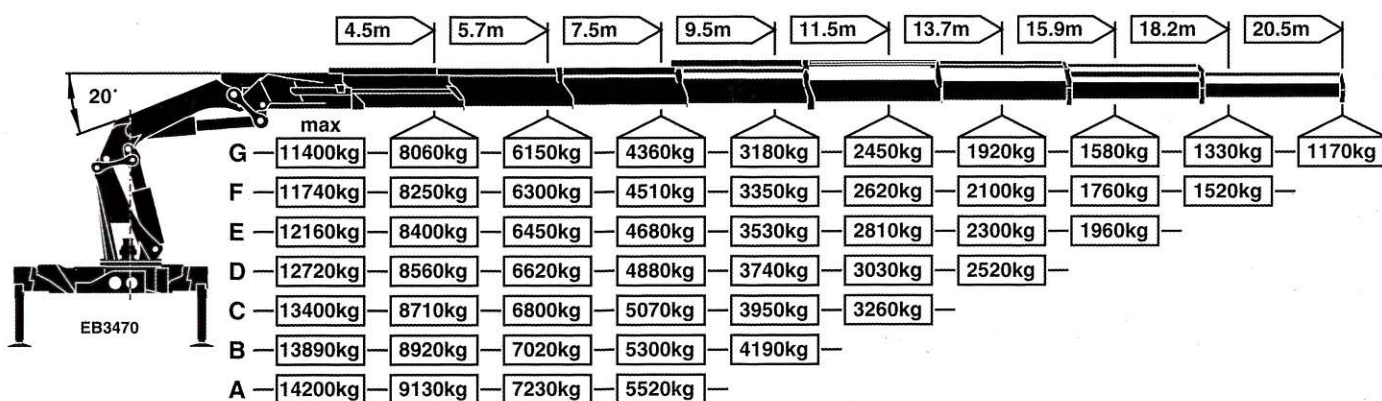

Los alcances están indicados con el brazo principal a 20° y por ello no son los alcances máximos de la grúa.

## PK 44002 Performance

### Datos técnicos (EN 12999 H1-B3)

Momento de elevación	42,5 t x m/416,9 kNm
Máx. capacidad	14500 Kg/142,2 kN
Alcance hidráulico máximo	20,6 m
Alcance mecánico máximo	24,8 m
Alcance máximo (con fly jib)	30,8 m
Angulo de giro	infinito

## PK 44002 Performance

### Grúa standard

Par de giro neto	4,5 t x m/44,1 kNm
Alcance	7,7 m
Anchura de apoyo standard	7,4 m
Espacio para montaje	min. 1,29 m máx. 1,46 m
Anchura grúa plegada	2,5 m
Présion de trabajo	330 bar
Caudal recomendado	
en servicio de telemando por radio y servicio LS	de 80 L/min a 100 L/min
Peso propio con gatos	4095 Kg